

Technical data sheet

Clamp clip 2056, H-foot, single, metal pressure trough, A4

Item number: 1188551



Clamp clip with hammerhead foot, metal pressure trough with rounded edges to protect the cable. For vertical and horizontal mounting of 1 single cable on a C-profile rail. For a slot width of 16–17 mm. With 1-start screw thread on pressure trough, universal hexagonal screw head WAF10, with slot and cross recess. Suitable for mounting indoors and outdoors. We recommend the use of a counter-trough.



A4 Stainless steel

2B Bright, treated

Master data

Item number	1188551
Type	BS-H1-M-70 A4
Description 1	Clamp clip 2056
Manufacturer	OBO
Dimension	64-70mm
Material	Stainless steel
Surface	Bright, treated
Surface standard	
Smallest sales unit	50
Unit of quantity	Piece
Weight	17.373 kg
Weight unit	kg/100 pc.

Technical data sheet

Clamp clip 2056, H-foot, single, metal pressure trough, A4



Item number: 1188551

Dimensions

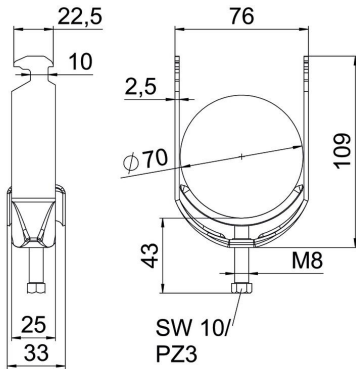

Length	25 mm
Width	76 mm
Height	109 mm
Plate thickness	2.5 mm
Dimension A	25 mm
Dimension B	76 mm
Dimension C	33 mm
Dimension G (mm)	M8
Dimension H	109 mm
Dimension L	43 mm
Dimension t	2.5 mm

Technical data

Number of cables/pipes	1
Maintain electrical functions	yes
For pipe diameter, max.	70 mm
For pipe diameter, min.	64 mm
for rail with slot width (with interval), max.	17 mm
for rail with slot width (with interval), min.	16 mm
Thread	M8
Halogen-free	yes
Length of external dimensions	33 mm
Max. Tightening torque	5 Nm
With metal trough	yes
Mounting type	Profile rail
Slot width	10 mm
Clamping range D, max.	70 mm
Clamping range D, min.	64 mm
Surface addition	Untreated
Material addition	Rustproof steel