

Technical data sheet

Support profile for PV module mounting, free-standing system

Item number: 5900530



Support profile to mount photovoltaic modules on free-standing systems. Mounting of support profile on pre-mounted supports with KV FT cross-connectors. Mounting of the PV modules on the support profile with end and/or connection clamps. Connection of multiple support profiles with LV FT straight connectors and KV FT cross-connectors, screw-on.

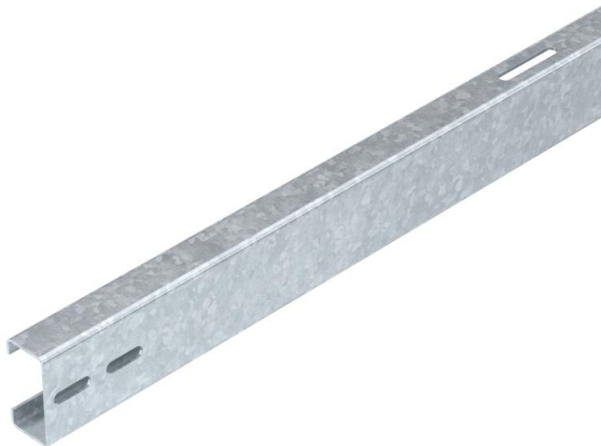

- St** Steel
- FT** Hot-dip galvanised

Master data

Item number	5900530
Description 1	Truss profile
Description 2	for free-standing system
Manufacturer	OBO
Dimension	40x80x6035
Colour	zinc
Material	Steel
Surface	Hot-dip galvanised
Surface standard	DIN EN ISO 1461
Smallest sales unit	1
Unit of quantity	Piece
Weight	2030 kg
Weight unit	kg/100 pc.

Technical data sheet

Support profile for PV module mounting, free-standing system

Item number: 5900530



Dimensions

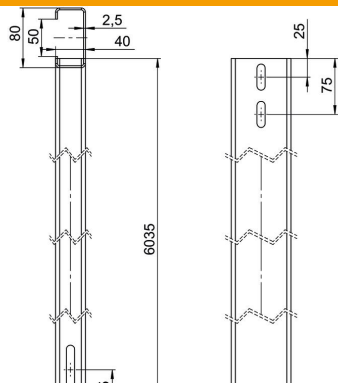

Length	6,035 mm
Width	40 mm
Height	80 mm

Technical data

Cable duct, integrated	no
Cable duct optional	no
Section modulus Sx	10600 mm ³
Section modulus Sy	5200 mm ³
Module width min.	1300 mm
Module width max.	1310 mm