

EGS



Device systems
Export GmbH & Co KG

2018/2019

Building Connections

OBO
BETTERMANN











Contact
Customer Service
+49 2373 89 - 1700

Service times
Monday to Friday 09.00 to 18.00

+49 2373 89 - 1238

export@obo.de
www.obo-bettermann.com

Planning and mounting aids

	Modul 45® – devices	5
	Modul 45® – device installation solutions for surface and concealed mounting	45
	Modul 45® and standard installation solutions for device installation ducts and service poles with an 80 mm system opening	49
	Modul 45connect® – plug-in installation solutions for device installation ducts and service poles	61
	Modul 45connect® – plug-in installation solutions for raised and cavity floor	79
	Workplace solutions – Deskboxes and Flexkanal	95
	Modul 45® and Standard – suspended power supply units VH/VHF	109
	Directories	125

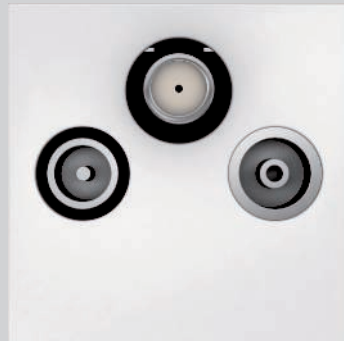

Modul 45® – devices







With their dimensions of 45 x 45 mm, the Modul 45 devices from OBO Bettermann are compact and space-saving. For this reason, the sockets, data and multimedia technology connections are ideal for use in under-floor systems, device installation ducts and service poles. The Modul 45 system makes optimum use of limited installation space.

The advantages of Modul 45 at a glance:

- Space savings thanks to compact design
- Modular structure
- Quick and easy planning
- Easy mounting
- High efficiency due to time and cost savings
- Wide range of application options
- Easy exchangeability



Modul 45® – devices

	Modul 45® – sockets	6
	Modul 45®, USB charging device	17
	Modul 45®, surge protection for sockets	18
	Modul 45®, switching devices	20
	Modul 45®, data technology solutions	22
	Modul 45®, multimedia solutions	31
	Modul 45®, installation components	43

Socket 0°, protective contact, single

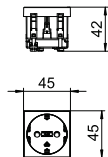

Type	STD-D0 RW1	STD-D0 ROR1	STD-D0 MZGN1	STD-D0 SRO1	STD-D0 SWGR1	STD-D0 AL1
Colour	Pure white	Pure orange	Mint green	Signal red	Black-grey	Aluminium painted
Pack. pcs	1	1	1	1	1	1
Weight kg/100 pcs.	4.200	4.200	4.200	4.200	4.200	4.200
Item No.	6120008	6120010	6120012	6120014	6120016	6120018

PC Polycarbonate

Protective contact socket single 0°, with increased touch protection, with screwless terminals, 2-pin, 16 A, 250 V~, with connection terminals to IEC 60884-1.

Socket 0°, protective contact, double

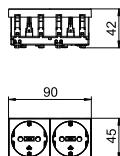

Type	STD-D0 RW2	STD-D0 ROR2	STD-D0 MZGN2	STD-D0 SRO2	STD-D0 SWGR2	STD-D0 AL2
Colour	Pure white	Pure orange	Mint green	Signal red	Black-grey	Aluminium painted
Pack. pcs	1	1	1	1	1	1
Weight kg/100 pcs.	8.000	8.000	8.000	8.000	8.000	8.000
Item No.	6120022	6120024	6120026	6120028	6120030	6120032

PC Polycarbonate

Protective contact socket double 0°, with increased touch protection, with screwless terminals, 2-pin, 16 A, 250 V~, with connection terminals to IEC 60884-1.

Socket 0°, protective contact, triple

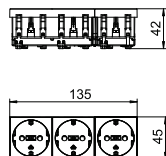

Type	STD-D0 RW3	STD-D0 ROR3	STD-D0 MZGN3	STD-D0 SRO3	STD-D0 SWGR3	STD-D0 AL3
Colour	Pure white	Pure orange	Mint green	Signal red	Black-grey	Aluminium painted
Pack. pcs	1	1	1	1	1	1
Weight kg/100 pcs.	12.200	12.200	12.200	12.200	12.200	12.200
Item No.	6120042	6120044	6120046	6120048	6120050	6120052

PC Polycarbonate

Protective contact socket triple 0°, with increased touch protection, with screwless terminals, 2-pin, 16 A, 250 V~, with connection terminals to IEC 60884-1.

Socket 0°, protective contact, encoded version, single

Type	Colour	Pack. pcs	Weight		Item No.
			kg/100 pcs.	pcs.	
STD-D0K SRO1	Signal red	1	4.200		6120292

PC Polycarbonate

Power socket single 0°, with increased touch protection with screwless terminals, 2-pin, 16 A, 250 V~, with connection terminals to IEC 60884-1.

The socket can only be used in conjunction with an encoding pin, type CST-STD.

Note: The encoding pin is not contained in the scope of supply.

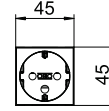
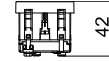

Socket 0°, protective contact, encoded version, double

Type	Colour	Pack. pcs	Weight		Item No.
			kg/100 pcs.	pcs.	
STD-D0K SRO2	Signal red	1	8.000		6120294

PC Polycarbonate

Power socket double 0°, with increased touch protection with screwless terminals, 2-pin, 16 A, 250 V~, with connection terminals to IEC 60884-1.

The socket can only be used in conjunction with an encoding pin, type CST-STD.

Note: The encoding pin is not contained in the scope of supply.

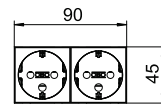
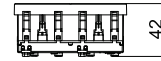

Socket 0°, protective contact, encoded version, triple

Type	Colour	Pack. pcs	Weight		Item No.
			kg/100 pcs.	pcs.	
STD-D0K SRO3	Signal red	1	12.200		6120296

PC Polycarbonate

Power socket triple 0°, with increased touch protection with screwless terminals, 2-pin, 16 A, 250 V~, with connection terminals to IEC 60884-1.

The socket can only be used in conjunction with an encoding pin, type CST-STD.

Note: The encoding pin is not contained in the scope of supply.

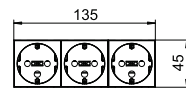
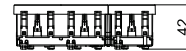

Encoding pin

Type	Colour	Pack. pcs	Weight		Item No.
			kg/100 pcs.	pcs.	
CST-STD K	Black-grey	10	0.200		6120797

PC Polycarbonate

Encoding pin as socket attachment for the use of encoded sockets, type STD.

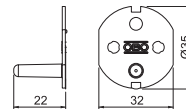

Strain relief for Modul 45 sockets 0°

Type	Colour	Pack. pcs	Weight		Item No.
			kg/100 pcs.	pcs.	
ZL-STD 0	Black	1	1.800		6120782

PC Polycarbonate

Strain relief for Modul 45 sockets, type STD, connectable at side, for the fastening of a 3-core cable, max. Ø 10 mm, suitable for protective contact sockets at direction of insertion 0° and sockets with earthing pin at direction of insertion 0°.

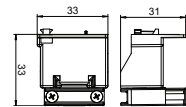

07_EGS_Produnkteilheitenkatalog_EX_2018 / en / 2018/10/08 08:19:15 (LLExport_02229) / 2018/10/08 08:22:22 08:22:22

Modul 45® devices

Socket 33°, protective contact, single

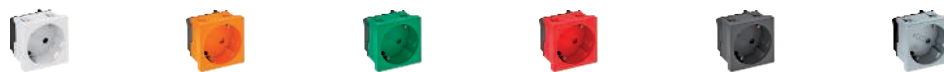
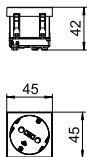

Type	STD-D3 RW1	STD-D3 ROR1	STD-D3 MZGN1	STD-D3 SRO1	STD-D3 SWGR1	STD-D3 AL1
Colour	Pure white	Pure orange	Mint green	Signal red	Black-grey	Aluminium painted
Pack. pcs	1	1	1	1	1	1
Weight kg/100 pcs.	4.000	4.000	4.000	4.000	4.000	4.000
Item No.	6120072	6120074	6120076	6120078	6120080	6120082

PC Polycarbonate

Protective contact socket single 33°, with increased touch protection, with screwless terminals, 2-pin, 16 A, 250 V~, with connection terminals to IEC 60884-1.

Socket 33°, protective contact, double

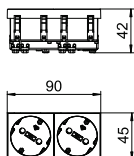

Type	STD-D3 RW2	STD-D3 ROR2	STD-D3 MZGN2	STD-D3 SRO2	STD-D3 SWGR2	STD-D3 AL2
Colour	Pure white	Pure orange	Mint green	Signal red	Black-grey	Aluminium painted
Pack. pcs	1	1	1	1	1	1
Weight kg/100 pcs.	7.800	7.800	7.800	7.800	7.800	7.800
Item No.	6120102	6120104	6120106	6120108	6120110	6120112

PC Polycarbonate

Protective contact socket double 33°, with increased touch protection, with screwless terminals, 2-pin, 16 A, 250 V~, with connection terminals to IEC 60884-1.

Socket 33°, protective contact, triple

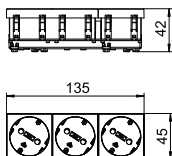

Type	STD-D3 RW3	STD-D3 ROR3	STD-D3 MZGN3	STD-D3 SRO3	STD-D3 SWGR3	STD-D3 AL3
Colour	Pure white	Pure orange	Mint green	Signal red	Black-grey	Aluminium painted
Pack. pcs	1	1	1	1	1	1
Weight kg/100 pcs.	11.000	11.000	11.000	11.000	11.000	11.000
Item No.	6120122	6120124	6120126	6120128	6120130	6120132

PC Polycarbonate

Protective contact socket triple 33°, with increased touch protection, with screwless terminals, 2-pin, 16 A, 250 V~, with connection terminals to IEC 60884-1.

Socket 33°, protective contact, encoded version, single

Type	Colour	Pack. pcs	Weight		Item No.
			kg/100	pcs.	
STD-D3K SRO1	Signal red	1	4.000		6120302

PC Polycarbonate

Power socket single 33°, with increased touch protection with screwless terminals, 2-pin, 16 A, 250 V~, with connection terminals to IEC 60884-1.

The socket can only be used in conjunction with an encoding pin, type CST-STD.

Note: The encoding pin is not contained in the scope of supply.

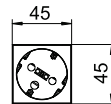
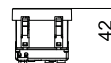

Socket 33°, protective contact, encoded version, double

Type	Colour	Pack. pcs	Weight		Item No.
			kg/100	pcs.	
STD-D3K SRO2	Signal red	1	7.700		6120304

PC Polycarbonate

Power socket double 33°, with increased touch protection with screwless terminals, 2-pin, 16 A, 250 V~, with connection terminals to IEC 60884-1.

The socket can only be used in conjunction with an encoding pin, type CST-STD.

Note: The encoding pin is not contained in the scope of supply.

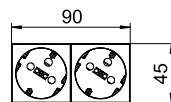
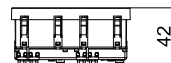

Socket 33°, protective contact, encoded version, triple

Type	Colour	Pack. pcs	Weight		Item No.
			kg/100	pcs.	
STD-D3K SRO3	Signal red	1	11.000		6120306

PC Polycarbonate

Power socket triple 33°, with increased touch protection with screwless terminals, 2-pin, 16 A, 250 V~, with connection terminals to IEC 60884-1.

The socket can only be used in conjunction with an encoding pin, type CST-STD.

Note: The encoding pin is not contained in the scope of supply.

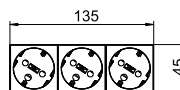
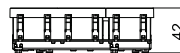

Encoding pin

Type	Colour	Pack. pcs	Weight		Item No.
			kg/100	pcs.	
CST-STD K	Black-grey	10	0.200		6120797

PC Polycarbonate

Encoding pin as socket attachment for the use of encoded sockets, type STD.

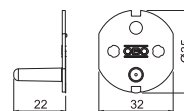

Socket 0°, with earthing pin, single

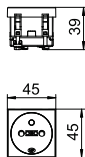

Type	STD-F0 RW1	STD-F0 ROR1	STD-F0 MZGN1	STD-F0 SRO1	STD-F0 SWGR1	STD-F0 AL1
Colour	Pure white	Pure orange	Mint green	Signal red	Black-grey	Aluminium painted
Pack. pcs	1	1	1	1	1	1
Weight kg/100 pcs.	4.000	4.000	4.000	4.000	4.000	4.000
Item No.	6120152	6120154	6120155	6120158	6120160	6120162

PC Polycarbonate

Socket with earthing pin single 0°, with increased touch protection with screwless terminals, 2-pin, 16 A, 250 V ~, with connection terminals to IEC 60884-1.

Socket 0°, with earthing pin, double

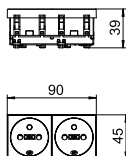

Type	STD-F0 RW2	STD-F0 ROR2	STD-F0 MZGN2	STD-F0 SRO2	STD-F0 SWGR2	STD-F0 AL2
Colour	Pure white	Pure orange	Mint green	Signal red	Black-grey	Aluminium painted
Pack. pcs	1	1	1	1	1	1
Weight kg/100 pcs.	7.700	7.700	7.700	7.700	7.700	7.700
Item No.	6120172	6120174	6120176	6120178	6120180	6120182

PC Polycarbonate

Socket with earthing pin double 0°, with increased touch protection with screwless terminals, 2-pin, 16 A, 250 V ~, with connection terminals to IEC 60884-1.

Socket 0°, with earthing pin, triple

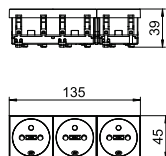

Type	STD-F0 RW3	STD-F0 ROR3	STD-F0 MZGN3	STD-F0 SRO3	STD-F0 SWGR3	STD-F0 AL3
Colour	Pure white	Pure orange	Mint green	Signal red	Black-grey	Aluminium painted
Pack. pcs	1	1	1	1	1	1
Weight kg/100 pcs.	11.800	11.800	11.800	11.800	11.800	11.800
Item No.	6120192	6120194	6120196	6120198	6120200	6120201

PC Polycarbonate

Socket with earthing pin triple 0°, with increased touch protection with screwless terminals, 2-pin, 16 A, 250 V ~, with connection terminals to IEC 60884-1.

Socket 0°, with earthing pin, encoded version, single

Type	Colour	Pack. pcs	Weight		Item No.
			kg/100 pcs.	pcs.	
STD-F0K SRO1	Signal red	1	4.000		6120312

PC Polycarbonate

Socket with earthing pin single 0°, encoded version, with increased touch protection, with screwless terminals, 2-pin, 16 A, 250 V~, with connection terminals to IEC 60884-1. The socket can only be used in conjunction with an encoding pin, type CST-STD.

Note: The encoding pin is not contained in the scope of supply.

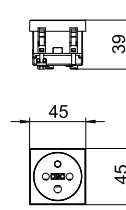

Socket 0°, with earthing pin, encoded version, double

Type	Colour	Pack. pcs	Weight		Item No.
			kg/100 pcs.	pcs.	
STD-F0K SRO2	Signal red	1	7.800		6120314

PC Polycarbonate

Socket with earthing pin double 0°, encoded version, with increased touch protection, with screwless terminals, 2-pin, 16 A, 250 V~, with connection terminals to IEC 60884-1. The socket can only be used in conjunction with an encoding pin, type CST-STD.

Note: The encoding pin is not contained in the scope of supply.

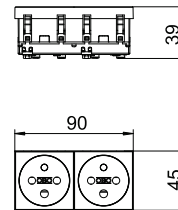

Socket 0°, with earthing pin, encoded version, triple

Type	Colour	Pack. pcs	Weight		Item No.
			kg/100 pcs.	pcs.	
STD-F0K SRO3	Signal red	1	11.800		6120316

PC Polycarbonate

Socket with earthing pin triple 0°, encoded version, with increased touch protection, with screwless terminals, 2-pin, 16 A, 250 V~, with connection terminals to IEC 60884-1. The socket can only be used in conjunction with an encoding pin, type CST-STD.

Note: The encoding pin is not contained in the scope of supply.

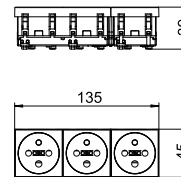

Encoding pin

Type	Colour	Pack. pcs	Weight		Item No.
			kg/100 pcs.	pcs.	
CST-STD K	Black-grey	10	0.200		6120797

PC Polycarbonate

Encoding pin as socket attachment for the use of encoded sockets, type STD.

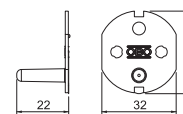

Strain relief for Modul 45 sockets 0°

Type	Colour	Pack. pcs	Weight		Item No.
			kg/100 pcs.	pcs.	
ZL-STD 0	Black	1	1.800		6120782

PC Polycarbonate

Strain relief for Modul 45 sockets, type STD, connectable at side, for the fastening of a 3-core cable, max. Ø 10 mm, suitable for protective contact sockets at direction of insertion 0° and sockets with earthing pin at direction of insertion 0°.

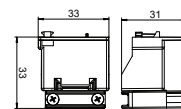

Socket 33°, with earthing pin, single

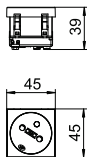

Type	STD-F3 RW1	STD-F3 ROR1	STD-F3 MZGN1	STD-F3 SRO1	STD-F3 SWGR1	STD-F3 AL1
Colour	Pure white	Pure orange	Mint green	Signal red	Black-grey	Aluminium painted
Pack. pcs	1	1	1	1	1	1
Weight kg/100 pcs.	3.800	3.800	3.800	3.800	3.800	3.800
Item No.	6120222	6120224	6120226	6120228	6120230	6120232

PC Polycarbonate

Socket with earthing pin single 33°, with increased touch protection with screwless terminals, 2-pin, 16 A, 250 V ~, with connection terminals to IEC 60884-1.

Socket 33°, with earthing pin, double

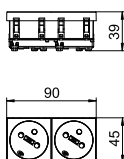

Type	STD-F3 RW2	STD-F3 ROR2	STD-F3 MZGN2	STD-F3 SRO2	STD-F3 SWGR2	STD-F3 AL2
Colour	Pure white	Pure orange	Mint green	Signal red	Black-grey	Aluminium painted
Pack. pcs	1	1	1	1	1	1
Weight kg/100 pcs.	7.500	7.500	7.500	7.500	7.500	7.500
Item No.	6120242	6120244	6120246	6120248	6120250	6120252

PC Polycarbonate

Socket with earthing pin double 33°, with increased touch protection with screwless terminals, 2-pin, 16 A, 250 V ~, with connection terminals to IEC 60884-1.

Socket 33°, with earthing pin, triple

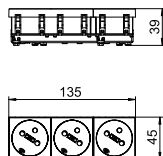

Type	STD-F3 RW3	STD-F3 ROR3	STD-F3 MZGN3	STD-F3 SRO3	STD-F3 SWGR3	STD-F3 AL3
Colour	Pure white	Pure orange	Mint green	Signal red	Black-grey	Aluminium painted
Pack. pcs	1	1	1	1	1	1
Weight kg/100 pcs.	10.500	10.500	10.500	10.500	10.500	10.500
Item No.	6120262	6120264	6120266	6120268	6120270	6120272

PC Polycarbonate

Socket with earthing pin triple 33°, with increased touch protection with screwless terminals, 2-pin, 16 A, 250 V ~, with connection terminals to IEC 60884-1.

Socket 33°, with earthing pin, encoded version, single

Type	Colour	Pack. pcs	Weight		Item No.
			kg/100 pcs.	pcs.	
STD-F3K SRO1	Signal red	1	3.800		6120322

PC Polycarbonate

Socket with earthing pin single 33°, encoded version, with increased touch protection, with screwless terminals, 2-pin, 16 A, 250 V~, with connection terminals to IEC 60884-1. The socket can only be used in conjunction with an encoding pin, type CST-STD.

Note: The encoding pin is not contained in the scope of supply.

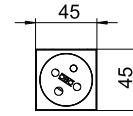
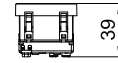

Socket 33°, with earthing pin, encoded version, double

Type	Colour	Pack. pcs	Weight		Item No.
			kg/100 pcs.	pcs.	
STD-F3K SRO2	Signal red	1	7.500		6120324

PC Polycarbonate

Socket with earthing pin double 33°, encoded version, with increased touch protection, with screwless terminals, 2-pin, 16 A, 250 V~, with connection terminals to IEC 60884-1. The socket can only be used in conjunction with an encoding pin, type CST-STD.

Note: The encoding pin is not contained in the scope of supply.

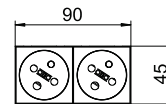
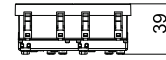

Socket 33°, with earthing pin, encoded version, triple

Type	Colour	Pack. pcs	Weight		Item No.
			kg/100 pcs.	pcs.	
STD-F3K SRO3	Signal red	1	10.500		6120326

PC Polycarbonate

Socket with earthing pin triple 33°, encoded version, with increased touch protection, with screwless terminals, 2-pin, 16 A, 250 V~, with connection terminals to IEC 60884-1. The socket can only be used in conjunction with an encoding pin, type CST-STD.

Note: The encoding pin is not contained in the scope of supply.

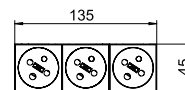
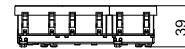

Encoding pin

Type	Colour	Pack. pcs	Weight		Item No.
			kg/100 pcs.	pcs.	
CST-STD K	Black-grey	10	0.200		6120797

PC Polycarbonate

Encoding pin as socket attachment for the use of encoded sockets, type STD.

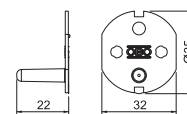

Socket 0°, Switzerland, single

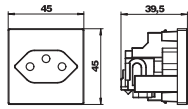

Type	Colour	Pack. pcs	Weight kg/100 pcs.	Item No.

PC Polycarbonate

Socket, single 0°, to Swiss standard (SEV), with screwless terminals, 2-pin, 10 A, 250 V~, type 13, with connection terminals to IEC 60884-1.

Socket 0°, Denmark, single

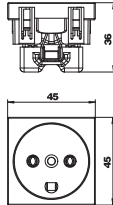

Type	Colour	Pack. pcs	Weight kg/100 pcs.	Item No.

PC Polycarbonate

Socket, single 0°, to Danish standard, with increased touch protection, with screw terminals, 2-pin, 16 A, 250 V~, with connection terminals to IEC 60884-1.

Socket 0°, Denmark, single, IT-encoded

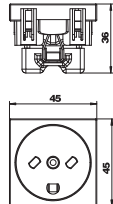

Type	Colour	Pack. pcs	Weight kg/100 pcs.	Item No.

PC Polycarbonate

Socket, single 0°, to Danish standard, encoded for IT power circuit, with screw terminals, 2-pin, 16 A, 250 V~, with connection terminals to IEC 60884-1.

Socket 0°, British Standard, single

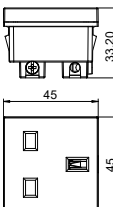

Type	Colour	Pack. pcs	Weight kg/100 pcs.	Item No.

PC Polycarbonate

Socket, single 0°, British Standard, conforming to BS 1363, with increased touch protection, with screw terminals, 2-pin, 13 A, 250 V~.

Socket 0° with switch, British Standard, single

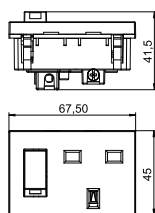

Type	Colour	Pack. pcs	Weight kg/100 pcs.	Item No.

PC Polycarbonate

Socket, single 0°, with switch, British Standard, conforming to BS 1363, with increased touch protection, with screw terminals, 2-pin, 13 A, 250 V~.

Socket 0°, Italy, single

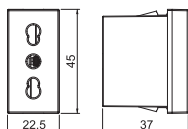

Type	Colour	Pack. pcs	Weight kg/100 pcs.	Item No.

PC Polycarbonate

Socket, single 0°, Italy P17/11, with increased touch protection, with screw terminals, 2-pin, 16 A, 250 V~.

Socket 0°, South Africa/India, 16 A, single

Type	Colour	Pack. pcs	Weight kg/100 pcs.	Item No.
STD-SA0 RW1	Pure white	1	5.000	6120730

PC Polycarbonate

Socket, single 0°, South Africa/India, conforming to BS 546, with increased touch protection, with screw terminals, 2-pin, 16 A, 250 V~.

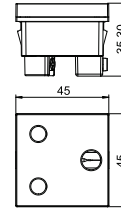

Socket 0° with switch, South Africa/India, 16 A, single

Type	Colour	Pack. pcs	Weight kg/100 pcs.	Item No.
STD-SA0G RW1.5	Pure white	1	6.700	6120734

PC Polycarbonate

Socket, single 0°, with switch, South Africa/India, conforming to BS 546, with increased touch protection, with screw terminals, 2-pin, 16 A, 250 V~.

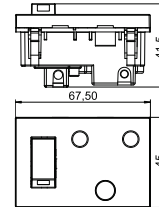

Socket 0°, South Africa/India, 16 A, encoded version, single

Type	Colour	Pack. pcs	Weight kg/100 pcs.	Item No.
STD-SA0K SRO1	Signal red	1	5.000	6120732

PC Polycarbonate

Socket, single 0°, South Africa/India, encoded version, conforming to BS 546, with increased touch protection, with screw terminals, 2-pin, 16 A, 250 V~.

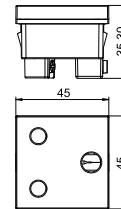

Socket 0°, with switch, South Africa/India, 16 A, encoded version, single

Type	Colour	Pack. pcs	Weight kg/100 pcs.	Item No.
STD-SA0GK SRO1.5	Signal red	1	6.700	6120736

PC Polycarbonate

Socket, single 0°, with switch, South Africa/India, encoded version, conforming to BS 546, with increased touch protection, with screw terminals, 2-pin, 16 A, 250 V~.

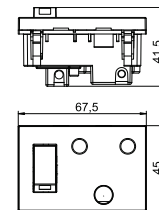

Socket 0°, India, combination IA6A3-EURO, single

Type	Colour	Pack. pcs	Weight kg/100 pcs.	Item No.
STD-IN0M RW1	Pure white	1	5.300	6120728

PC Polycarbonate

Socket, single 0°, India, combination IA6A3/Euro plug, with increased touch protection, with screw terminals, 2-pin, 6 A, 250 V~.

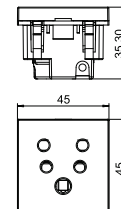

Socket 0°, India, 5 A, single

Type	Colour	Pack. pcs	Weight kg/100 pcs.	Item No.
STD-IN0 RW1	Pure white	1	4.300	6120726

PC Polycarbonate

Socket, single 0°, India, conforming to BS 546, with increased touch protection, with screw terminals, 2-pin, 5 A, 250 V~.

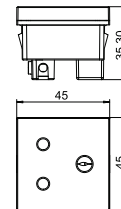

Socket 0°, multi-standard, single

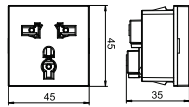

Type	Colour	Pack.		Weight	Item No.
		pcs	kg/100 pcs.		
STD-MS0 RW1	Pure white	1	4.000		6120738

PC Polycarbonate

Socket, single 0°, multi-standard version, with increased touch protection, with screw terminals, 2-pin, 5/6/10/13 A, 250 V~.

This socket may not be used in Europe. Country-specific standards and directives must be observed.

Socket 0°, China, 10 A, single

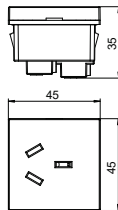

Type	Colour	Pack.		Weight	Item No.
		pcs	kg/100 pcs.		
STD-CN0A10 RW1	Pure white	1	4.000		6120740

PC Polycarbonate

Socket, single 0°, China, with increased touch protection, with screw terminals, 2-pin, 10 A, 250 V~.

Socket 0°, China, 16 A, single

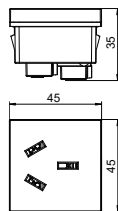

Type	Colour	Pack.		Weight	Item No.
		pcs	kg/100 pcs.		
STD-CN0A16 RW1	Pure white	1	4.100		6120742

PC Polycarbonate

Socket, single 0°, China, with increased touch protection, with screw terminals, 2-pin, 16 A, 250 V~.

Socket 0°, China, combination CN-NEMA-EURO, single

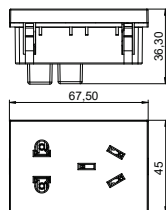

Type	Colour	Pack.		Weight	Item No.
		pcs	kg/100 pcs.		
STD-CN0M RW1.5	Pure white	1	5.800		6120744

PC Polycarbonate

Socket, single 0°, China, combination China-10A/NEMA-1/Euro plug, with increased touch protection, with screw terminals, 2-pin, 10 A, 250 V~.



Charge mobile devices such as smartphones or tablets simply and easily via the standard USB connection. The OBO USB charging device can charge up to two mobile devices simultaneously and can be integrated in device installation devices, in service poles and in underfloor systems. Typical areas of application are airports, hotels, conference centres or offices.

USB charging device

Type	Colour	Pack. pcs	Weight kg/100 pcs.	Item No.
MTG-2UC2.1 RW1	Pure white	1	5.500	6105300
MTG-2UC2.1 SWGR1	Black-grey	1	5.500	6105302
MTG-2UC2.1 AL1	Aluminium painted	1	5.500	6105304

PC Polycarbonate

USB charging device with two USB type A sockets, for charging 1–2 mobile devices, maximum charging current 1x 2100 mA or 2x 1050 mA.

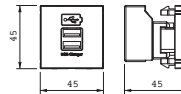

Fine power protection / dado duct installation Modul 45

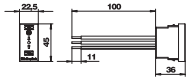

Type

Signalling on device
Version

Pack. pcs
Weight kg/100 pcs.

Item No.

ÜSS 45-O-RW

Visual
Visual
function display

1
2.411

6117473

Surge protection / network fine protection, type 3, according to EN 61643-11 for installation in Rapid 45 ducts, device installation ducts and underfloor systems.

- Version-O with acoustic function display
- Quick and easy mounting
- Low construction width of 22.5 mm

Application: The surge protection device secures downstream and nearby sockets.

Fine power protection / dado duct installation Modul 45

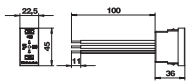

Type

Signalling on device
Version

Pack. pcs
Weight kg/100 pcs.

Item No.

ÜSS 45-A-RW

Audible
Acoustic
function display

1
2.800

6117465

Surge protection / network fine protection, type 3, according to EN 61643-11 for installation in Rapid 45 ducts, device installation ducts and underfloor systems.

- Version-A with acoustic function display (switchable signal tone)
- Quick and easy mounting
- Low construction width of 22.5 mm

Application: The surge protection device secures downstream and nearby sockets.



Fine power protection for all installation systems



Type	Signalling on device	Version	Pack. pcs	Weight kg/100 pcs.	Item No.
ÜSM-A	Audible	Acoustic function display	1	1.500	5092451

Surge protection module type 3 to DIN EN 61643-11 for 230 V power grids.

- With acoustic defect signal
- With low construction height
- Halogen-free plastic (UL 94 V-0)
- Y circuit

Application: Universally applicable for all installation systems.



Dimensions

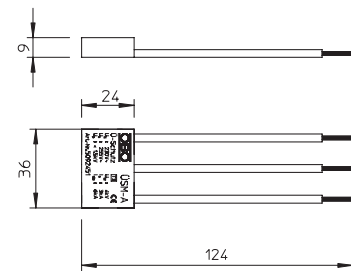

Connection options

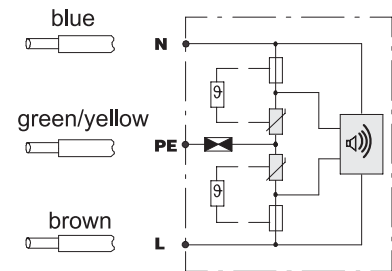

Surge protection module with support

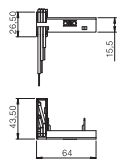

Type	ÜSM-A-4T
Signalling on device	Audible
Pack. pcs	1
Weight kg/100 pcs.	2.226
Item No.	6107801

2-pin surge protection module, 16 A/250 V~, with acoustic default display, no network switch-off, for connection to a multiple socket of type Modul 45connect using the supplied support. For installation in universal supports UT3/45 and UT4/45. The surge protection module meets EN 61643-11, type 3, Class III, requirements Class D.



One-way/changeover switch, 1/2 module

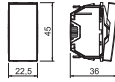

Type	Colour	Pack. pcs	Weight kg/100 pcs.	Item No.
WS-UB RW0.5	Pure white	1	1.800	6120920
WS-UB SWGR0.5	Black-grey	1	1.800	6120922
WS-UB AL0.5	Aluminium painted	1	1.800	6120924

PC Polycarbonate

Changeover switch 1-pin, 10 A, 250 V~, with screwless terminals.

One-way/changeover switch with warning lamp, 1/2 module

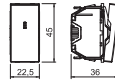

Type	Colour	Pack. pcs	Weight kg/100 pcs.	Item No.
WS-UKL RW0.5	Pure white	1	1.800	6120926
WS-UKL SWGR0.5	Black-grey	1	1.800	6120928
WS-UKL AL0.5	Aluminium painted	1	1.800	6120930

PC Polycarbonate

Changeover switch with LED element as control luminaire, 1-pole, 10 A, 250 V~, with screwless terminals.

One-way/changeover switch, 1 module

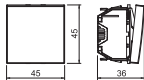

Type	Colour	Pack. pcs	Weight kg/100 pcs.	Item No.
WS-UB RW1	Pure white	1	2.600	6120932
WS-UB SWGR1	Black-grey	1	2.600	6120934
WS-UB AL1	Aluminium painted	1	2.300	6120936

PC Polycarbonate

Changeover switch 1-pin, 10 A, 250 V~, with screwless terminals.

One-way/changeover switch with warning lamp, 1 module

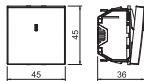

Type	Colour	Pack. pcs	Weight kg/100 pcs.	Item No.
WS-UKL RW1	Pure white	1	2.300	6120938
WS-UKL SWGR1	Black-grey	1	2.300	6120940
WS-UKL AL1	Aluminium painted	1	2.300	6120942

PC Polycarbonate

Changeover switch with LED element as control luminaire, 1-pole, 10 A, 250 V~, with screwless terminals.

Roller blind switch, 1 module

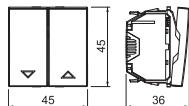

Type	Colour	Pack. pcs	Weight kg/100 pcs.	Item No.
RS-BS RW1	Pure white	1	3.700	6120950
RS-BS SWGR1	Black-grey	1	3.700	6120952
RS-BS AL1	Aluminium painted	1	3.700	6120954

PC Polycarbonate

Roller blind switch with electrical and mechanical lock, 1-pin, 10 A, 250 V~, with screwless terminals.

Changeover switch, 1/2 module



Type	Colour	Pack. pcs	Weight kg/100 pcs.	Item No.
TA-WB RW0.5	Pure white	1	1.800	6120960
TA-WB SWGR0.5	Black-grey	1	1.800	6120962
TA-WB AL0.5	Aluminium painted	1	1.800	6120964

PC Polycarbonate

Changeover switch, 1-pin, 10 A, 250 V~, with screwless terminals.

Changeover switch, 1 module

Type	Colour	Pack. pcs	Weight kg/100 pcs.	Item No.
TA-WB RW1	Pure white	1	3.300	6120966
TA-WB SWGR1	Black-grey	1	3.300	6120968
TA-WB AL1	Aluminium painted	1	3.300	6120970

PC Polycarbonate

Changeover switch, 1-pin, 10 A , 250 V~, with screwless terminals.

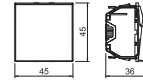

Roller blind button, 1 module

Type	Colour	Pack. pcs	Weight kg/100 pcs.	Item No.
RT-BS RW1	Pure white	1	3.700	6120980
RT-BS SWGR1	Black-grey	1	3.700	6120982
RT-BS AL1	Aluminium painted	1	3.700	6120984

PC Polycarbonate

Roller blind button with electrical locking, 1-pin, 10 A, 250 V~, with screwless terminals.

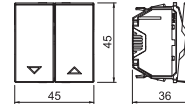

Adapter for switch installation rotated through 90°

Type	Pack. pcs	Weight kg/100 pcs.	Item No.
AD-90G M45-1	1	2.200	6120992

St Steel

The adapter allows switch installation rotated through 90° in, for example, service poles with a 45 mm track or Rapid 45. Suitable for all switches and buttons in one module width (45 x 45 mm).

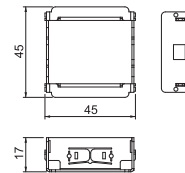

Data technology support, 1 module, straight outlet, type RM

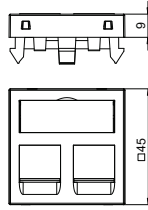

Type	Colour	Pack.	Weight	Item No.
		pcs	kg/100 pcs.	
DTG-2RM RW1	Pure white	1	1.100	6119292
DTG-2RM SWGR1	Black-grey	1	1.100	6119294
DTG-2RM AL1	Aluminium painted	1	1.100	6119296

PC Polycarbonate

The type RM data technology support is suitable for accepting the following data connection modules: Types ASM-C5, ASM-C5 G, ASM-C6 and ASM-C6 G; R&M: Cat.5 and Cat.6 modules without support plate.

Data technology support, 1 module, slanting outlet, type RM

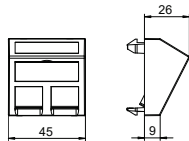

Type	Colour	Pack.	Weight	Item No.
		pcs	kg/100 pcs.	
DTS-2RM RW1	Pure white	1	2.900	6119298
DTS-2RM SWGR1	Black-grey	1	2.900	6119300
DTS-2RM AL1	Aluminium painted	1	2.900	6119302

PC Polycarbonate

The type RM data technology support is suitable for accepting the following data connection modules: Types ASM-C5, ASM-C5 G, ASM-C6 and ASM-C6 G; R&M: Cat.5 and Cat.6 modules without support plate.

Data technology support, 1 module, unshielded outlet, type RM

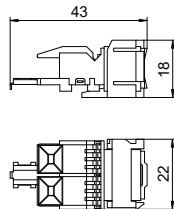

Type	Pack.	Weight	Item No.
	pcs	kg/100 pcs.	
ASM-C5 S	1	1.120	6117347

Connection module Cat. 5e unshielded, with a RJ45 slot. Including a dust cover, a cable tie, a snap-in fastening frame and mounting instructions. Suitable for installation in support plates, type MTM 2C and MTM 3C, mounting plate type MPR2 2C, mounting support type MTGE2 2C, MTGE2 15 2C and MTGE2 F 2C.

RJ45 data connection module, Cat. 5e, unshielded

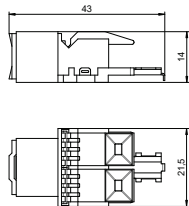

Type	Pack.	Weight	Item No.
	pcs	kg/100 pcs.	
ASM-C5	1	1.120	6117337

Connection module Cat. 5e unshielded, with a RJ 45 slot. Including a dust cover, a cable tie and mounting instructions. Suitable for installation in data technology supports of type DTG-2RM and DTS-2RM.

RJ45 data connection module, Cat. 5e, shielded

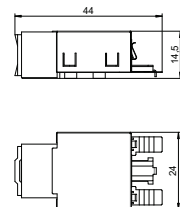

Type	Pack.	Weight	Item No.
	pcs	kg/100 pcs.	
ASM-C5 G	1	2.660	6117325

Connection module Cat. 5e shielded, with a RJ 45 slot. Includes an EMC screen hood, a dust cover, a cable tie and mounting instructions. Suitable for installation in data technology supports of type DTG-2RM and DTS-2RM.

RJ45 data connection module, Cat. 6, unshielded

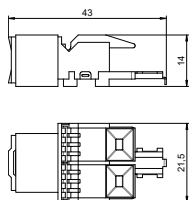

Type	Pack.	Weight	Item No.
	pcs	kg/100 pcs.	
ASM-C6	1	1.060	6117341

Connection module Cat. 6 unshielded, with a RJ 45 slot. Including a dust cover, a cable tie and mounting instructions. Suitable for installation in data technology supports of type DTG-2RM and DTS-2RM.

RJ45 data connection module, Cat. 6, shielded

Type	Pack. pcs	Weight kg/100 pcs.	Item No.
ASM-C6 G	1	1.850	6117329

Connection module Cat. 6 shielded, with a RJ 45 slot. Includes an EMC screen hood, a dust cover, a cable tie and mounting instructions. Suitable for installation in data technology supports of type DTG-2RM and DTS-2RM.

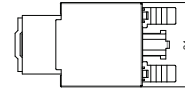
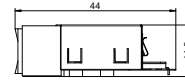

Data technology support, 1 module, straight outlet, type C

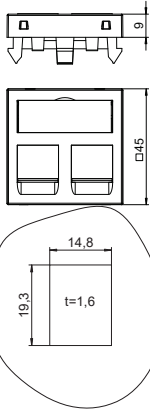

Type	Colour	Pack.	Weight	Item No.
		pcs	kg/100 pcs.	
DTG-2C RW1	Pure white	1	1.100	6119214
DTG-2C SWGR1	Black-grey	1	1.100	6119216
DTG-2C AL1	Aluminium painted	1	1.100	6119218

PC Polycarbonate

The type C data technology support is suitable for accepting the following data connection modules: BTR (Keystone design): Cat. 6A module and UAE module; Corning: modules with Keystone seat; CobiNet: CobiDat KS module; Dätwyler: KS-T, KS-TS, MS-K and KU-T; EKU: E-Stone; Harting: Prelink Keystone Cat. 6A; Fixlink Keystone Cat. 6A; Komos: KDM 500 module; Leoni Kerpen: MegaLine-Connect45 Keystone socket modules; OBO: Type ASM-C6A and ASM-C6A G; R&M: Cat. 6A with Keystone fastening; Rutenbeck: UM and UMflex; SETEC: UKJ and XKJ; Telegärtner: AMJ and UMJ.

Data technology support, 1 module, slanting outlet, type C

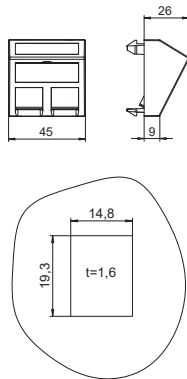

Type	Colour	Pack.	Weight	Item No.
		pcs	kg/100 pcs.	
DTS-2C RW1	Pure white	1	1.500	6119250
DTS-2C SWGR1	Black-grey	1	1.500	6119252
DTS-2C AL1	Aluminium painted	1	1.500	6119254

PC Polycarbonate

The type C data technology support is suitable for accepting the following data connection modules: BTR (Keystone design): Cat. 6A module and UAE module; Corning: modules with Keystone seat; CobiNet: CobiDat KS module; Dätwyler: KS-T, KS-TS, MS-K and KU-T; EKU: E-Stone; Harting: Prelink Keystone Cat. 6A; Fixlink Keystone Cat. 6A; Komos: KDM 500 module; Leoni Kerpen: MegaLine-Connect45 Keystone socket modules; OBO: Type ASM-C6A and ASM-C6A G; R&M: Cat. 6A with Keystone fastening; Rutenbeck: UM and UMflex; SETEC: UKJ and XKJ; Telegärtner: AMJ and UMJ.

Connection module Cat. 6A, unshielded, snap-In

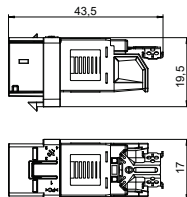

Type	Pack.	Weight	Item No.
	pcs	kg/100 pcs.	
ASM-C6A	1	1.050	6117348

Connection module Cat. 6A (ISO) unshielded, with a RJ45 slot. Including a dust cover, a cable tie, a Keystone fastening frame and mounting instructions. Suitable for installation in the data technology supports of type DTG-2C and DTS-2C, support plate of type MTM 2C and MTM 3C, mounting plate of type MPR2 2C, mounting supports of type MTGE2 2C, MTGE2 15 2C and MTGE2 F 2C.

Connection module Cat. 6A, shielded, snap-In

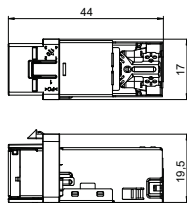

Type	Pack.	Weight	Item No.
	pcs	kg/100 pcs.	
ASM-C6A G	1	1.630	6117346

Connection module Cat. 6A (ISO) shielded, with a RJ45 slot. Including an EMC screen hood, a dust cover, a cable tie, a Keystone fastening frame and mounting instructions. Suitable for installation in the data technology supports of type DTG-2C and DTS-2C, support plate of type MTM 2C and MTM 3C, mounting plate of type MPR2 2C, mounting supports of type MTGE2 2C, MTGE2 15 2C and MTGE2 F 2C.

Selection aid – installation of data technology modules from different manufacturers

Manufacturer	Data technology module	Data technology support
3M	Volition K6	Type C (without dust protection slider)
3M	Volition CAT6A	Type C (without dust protection slider)
AMP/Tyco	SL Series 110Connect (without dust protection flap)	Type A
AMP/Tyco	SL Series Toolless (without dust protection flap)	Type A
Avaya/Systimax	M series	Type F
Brand-Rex	Modules with the item number ending ...JAKS000CR	Type A
Brand-Rex	Modules with the item number ending ...JAKU002	Type A
BTR Netcom	Cat.6A Modul (Keystone design)	Type C
BTR Netcom	UTP Modul (Keystone design)	Type C
BTR Netcom	Cat.6A Modul (module design)	Type B
BTR Netcom	E-DAT Modul (module design)	Type B
BTR Netcom	UAE Modul (module design)	Type B
CobiNet	CobiDat KS	Type C
Corning	Modules with Keystone retainer	Type C
Dätwyler Cables	MS module	Type B
Dätwyler Cables	MS-N module	Type B
Dätwyler Cables	KS-T and KS-TS module	Type C
Dätwyler Cables	MS-K module	Type C
Dätwyler Cables	KU-T module	Type C
EKU	E-Stone module	Type C
Harting	Prelink RJ45 Keystone module Cat.6A	Type C
Harting	Fixlink RJ45 Keystone module Cat.6A	Type C
Komos	KDM 500 module	Type C
Leoni Kerpen	VarioKeystone, Cat. 6A socket module	Type B
Leoni Kerpen	MegaLine Connect100, socket module Cat. 6A and 8C7A	Type B
Leoni Kerpen	MegaLine Connect45, Keystone socket module	Type C
Leoni Kerpen	MegaLine Connect45, ELine	Type EP
Lexcom/Schneider	LexCom 125	Type LE
Lexcom/Schneider	LexCom 250	Type LE
Lexcom/Schneider	LexCom 500	Type LE
Nexans	LANmark RJ45 with blue adapter clip	Type A
Nexans	LANmark GG45 with metal clip	Type A
OBO Bettermann	Connection module, type ASM-C6A	Type C
OBO Bettermann	Connection module, type ASM-C6A G	Type C
OBO Bettermann	Connection module, type ASM-C5	Type RM
OBO Bettermann	Connection module, type ASM-C5 G	Type RM
OBO Bettermann	Connection module, type ASM-C6	Type RM
OBO Bettermann	Connection module, type ASM-C6 G	Type RM
Panduit	Mini-Com	Type PA
R&M	Cat. 6A module with Keystone fastening	Type C
R&M	Cat. 5 and Cat. 6 modules without support plate	Type RM
Rutenbeck	UM module	Type C
Rutenbeck	Umflex module	Type C
SETEC	UKJ module	Type C
SETEC	XKJ module	Type C
Telegärtner	AMJ module	Type C
Telegärtner	UMJ module	Type C



Data technology support, 1 module, straight outlet, type A

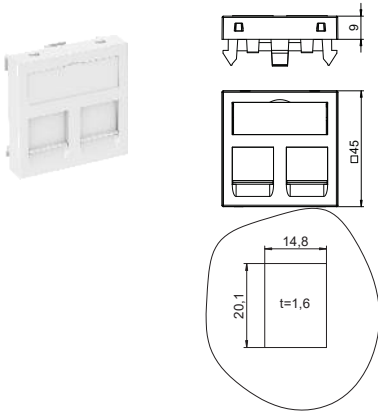

Type	Colour	Pack.	Weight	Item No.
		pcs	kg/100 pcs.	
DTG-2A RW1	Pure white	1	1.100	6119202
DTG-2A SWGR1	Black-grey	1	1.100	6119204
DTG-2A AL1	Aluminium painted	1	1.100	6119206

PC Polycarbonate

Data technology support with straight outlet and locking slider to accept two data technology connection modules with RJ45 socket. The locking fastening is suitable for horizontal and vertical installation in the system environment. Type A has a mounting opening of 20.10 x 14.80 mm and is designed for direct fastening of the data connection modules in the mounting opening.

The Type A data technology support is suitable for accepting the following data connection modules: AMP TYCO (without dust protection cap): SL Series 110Connect and SL Series Toolless; Brand-Rex: modules with item numbers ending in ...JAKS000CR and ...JAKU002; Nexans: LANmark RJ45 with blue adapter clip, LANmark GG45 with metal clip.

Data technology support, 1 module, slanting outlet, type A

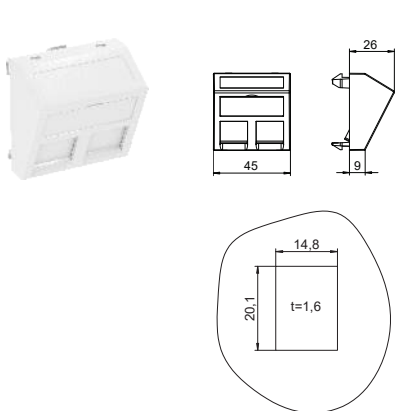

Type	Colour	Pack.	Weight	Item No.
		pcs	kg/100 pcs.	
DTS-2A RW1	Pure white	1	2.000	6119238
DTS-2A SWGR1	Black-grey	1	1.500	6119240
DTS-2A AL1	Aluminium painted	1	1.500	6119242

PC Polycarbonate

Data technology support with slanting outlet and locking slider to accept two data technology connection modules with RJ45 socket. The locking fastening is suitable for horizontal and vertical installation in the system environment. Type A has a mounting opening of 20.10 x 14.80 mm and is designed for direct fastening of the data connection modules in the mounting opening.

The Type A data technology support is suitable for accepting the following data connection modules: AMP TYCO (without dust protection cap): SL Series 110Connect and SL Series Toolless; Brand-Rex: modules with item numbers ending in ...JAKS000CR and ...JAKU002; Nexans: LANmark RJ45 with blue adapter clip, LANmark GG45 with metal clip.

Data technology support, 1 module, straight outlet, type B

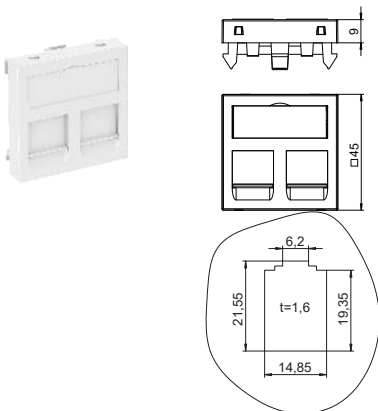

Type	Colour	Pack.	Weight	Item No.
		pcs	kg/100 pcs.	
DTG-2B RW1	Pure white	1	1.100	6119208
DTG-2B SWGR1	Black-grey	1	1.100	6119210
DTG-2B AL1	Aluminium painted	1	1.100	6119212

PC Polycarbonate

Data technology support with straight outlet and locking slider to accept two data technology connection modules with RJ45 socket. The locking fastening is suitable for horizontal and vertical installation in the system environment. Type B has a mounting opening of 19.35/21.55 x 14.85 mm and is designed for direct fastening of the data connection modules in the mounting opening.

The type B data technology support is suitable for accepting the following data connection modules: BTR (module design): Cat. 6A Modul, E-DAT module and UAE module; Dätwyler: MS and MS-N, Leoni Kerpen: VarioKeystone socket module Cat. 6A and MegaLine-Connect100 socket module Cat. 6A and 8C7A.

Data technology support, 1 module, slanting outlet, type B

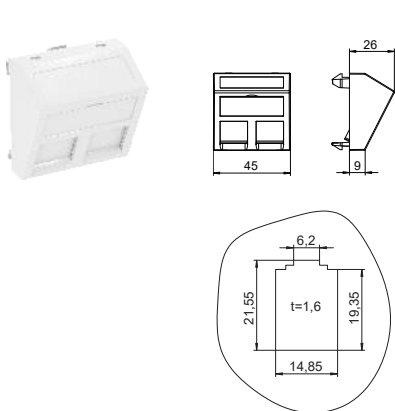

Type	Colour	Pack.	Weight	Item No.
		pcs	kg/100 pcs.	
DTS-2B RW1	Pure white	1	1.500	6119244
DTS-2B SWGR1	Black-grey	1	1.500	6119246
DTS-2B AL1	Aluminium painted	1	1.500	6119248

PC Polycarbonate

Data technology support with slanting outlet and locking slider to accept two data technology connection modules with RJ45 socket. The locking fastening is suitable for horizontal and vertical installation in the system environment. Type B has a mounting opening of 19.35/21.55 x 14.85 mm and is designed for direct fastening of the data connection modules in the mounting opening.

The type B data technology support is suitable for accepting the following data connection modules: BTR (module design): Cat. 6A Modul, E-DAT module and UAE module; Dätwyler: MS and MS-N, Leoni Kerpen: VarioKeystone socket module Cat. 6A and MegaLine-Connect100 socket module Cat. 6A and 8C7A.

Data technology support, 1 module, straight outlet, type C

Type	Colour	Pack.	Weight	Item No.
		pcs	kg/100 pcs.	
DTG-2C RW1	Pure white	1	1.100	6119214
DTG-2C SWGR1	Black-grey	1	1.100	6119216
DTG-2C AL1	Aluminium painted	1	1.100	6119218

PC Polycarbonate

Data technology support with straight outlet and locking slider to accept two data technology connection modules with RJ45 socket. The locking fastening is suitable for horizontal and vertical installation in the system environment. Type C has a mounting opening of 19.30 x 14.80 mm and is designed for direct fastening of the data connection modules in the mounting opening.

The type C data technology support is suitable for accepting the following data connection modules: BTR (Keystone design): Cat. 6A module and UAE module; Corning: modules with Keystone seat; CobiNet: CobiDat KS module; Dätwyler: KS-T, KS-TS, MS-K and KU-T; EKU: E-Stone; Harting: Prelink Keystone Cat. 6A; Fixlink Keystone Cat. 6A; Komos: KDM 500 module; Leoni Kerpen: MegaLine-Connect45 Keystone socket modules; OBO: Type ASM-C6A and ASM-C6A G; R&M: Cat. 6A with Keystone fastening; Rutenbeck: UM and UMflex; SETEC: UKJ and XKJ; Telegärtner: AMJ and UMJ.

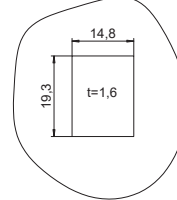
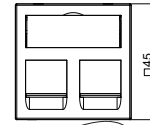
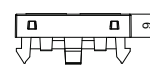

Data technology support, 1 module, slanting outlet, type C

Type	Colour	Pack.	Weight	Item No.
		pcs	kg/100 pcs.	
DTS-2C RW1	Pure white	1	1.500	6119250
DTS-2C SWGR1	Black-grey	1	1.500	6119252
DTS-2C AL1	Aluminium painted	1	1.500	6119254

PC Polycarbonate

Data technology support with slanting outlet and locking slider to accept two data technology connection modules with RJ45 socket. The locking fastening is suitable for horizontal and vertical installation in the system environment. Type C has a mounting opening of 19.30 x 14.80 mm and is designed for direct fastening of the data connection modules in the mounting opening.

The type C data technology support is suitable for accepting the following data connection modules: BTR (Keystone design): Cat. 6A module and UAE module; Corning: modules with Keystone seat; CobiNet: CobiDat KS module; Dätwyler: KS-T, KS-TS, MS-K and KU-T; EKU: E-Stone; Harting: Prelink Keystone Cat. 6A; Fixlink Keystone Cat. 6A; Komos: KDM 500 module; Leoni Kerpen: MegaLine-Connect45 Keystone socket modules; OBO: Type ASM-C6A and ASM-C6A G; R&M: Cat. 6A with Keystone fastening; Rutenbeck: UM and UMflex; SETEC: UKJ and XKJ; Telegärtner: AMJ and UMJ.

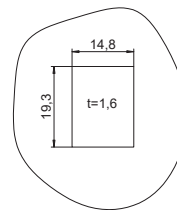
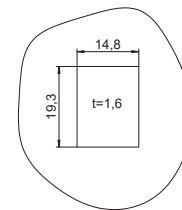
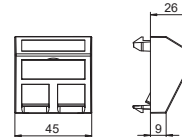

Data technology support, 1 module, straight outlet, type C, without dust protection slider

Type	Colour	Pack.	Weight	Item No.
		pcs	kg/100 pcs.	
DTG-02C RW1	Pure white	1	1.000	6119280
DTG-02C SWGR1	Black-grey	1	1.000	6119282
DTG-02C AL1	Aluminium painted	1	1.000	6119284

PC Polycarbonate

Data technology support with straight outlet and without a locking slider to accept two data technology connection modules with RJ45 socket. The locking fastening is suitable for horizontal and vertical installation in the system environment. Type C has a mounting opening of 19.30 x 14.80 mm and is designed for direct fastening of the data connection modules in the mounting opening.

The type C data technology support (without dust protection slider) is suitable for accepting the following data connection modules: 3M: Volition K6, K10 and Cat. 6A.

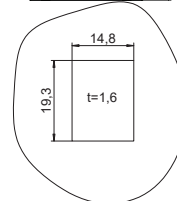
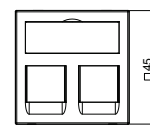
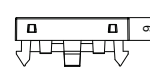

07_EGS_Produnkteilheitenkatalog_EX_2018 / en / 2018/10/08 08:19:15 08:19:15 (LLE:export_02229) / 2018/10/08 08:22:22 08:22:22

Modul 45® devices



Data technology support, 1 module, slanting outlet, type C, without dust protection slider

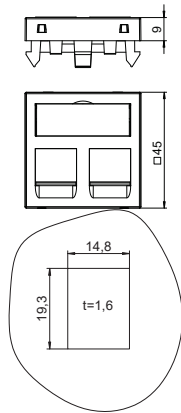

Type	Colour	Pack. pcs	Weight kg/100 pcs.	Item No.
DTS-02C RW1	Pure white	1	1.400	6119286
DTS-02C SWGR1	Black-grey	1	1.400	6119288
DTS-02C AL1	Aluminium painted	1	1.400	6119290

PC Polycarbonate

Data technology support with slanting outlet and without a locking slider to accept two data technology connection modules with RJ45 socket. The locking fastening is suitable for horizontal and vertical installation in the system environment. Type C has a mounting opening of 19.30 x 14.80 mm and is designed for direct fastening of the data connection modules in the mounting opening.

The type C data technology support (without dust protection slider) is suitable for accepting the following data connection modules: 3M: Volition K6, K10 and Cat. 6A.

Data technology support, 1 module, straight outlet, type EP

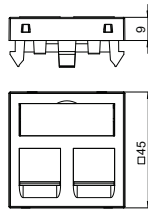

Type	Colour	Pack. pcs	Weight kg/100 pcs.	Item No.
DTG-2EP RW1	Pure white	1	1.100	6119232
DTG-2EP SWGR1	Black-grey	1	1.100	6119234
DTG-2EP AL1	Aluminium painted	1	1.100	6119236

PC Polycarbonate

Data technology support with straight outlet and locking slider to accept two data technology connection modules with RJ45 socket. The locking fastening is suitable for horizontal and vertical installation in the system environment. Type EP has a special module seat and is designed for indirect fastening of the data connection modules in the mounting opening.

The type EP data technology support is suitable for accepting the following data connection modules: Leoni Kerpen: MegaLine-Connect45 ELine.

Data technology support, 1 module, slanting outlet, type EP

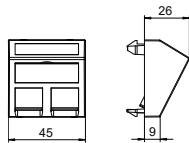

Type	Colour	Pack. pcs	Weight kg/100 pcs.	Item No.
DTS-2EP RW1	Pure white	1	1.500	6119268
DTS-2EP SWGR1	Black-grey	1	1.500	6119270
DTS-2EP AL1	Aluminium painted	1	1.500	6119272

PC Polycarbonate

Data technology support with slanting outlet and locking slider to accept two data technology connection modules with RJ45 socket. The locking fastening is suitable for horizontal and vertical installation in the system environment. Type EP has a special module seat and is designed for indirect fastening of the data connection modules in the mounting opening.

The type EP data technology support is suitable for accepting the following data connection modules: Leoni Kerpen: The type EP data technology support is suitable for accepting the following data connection modules: Leoni Kerpen: MegaLine-Connect45 ELine.

Data technology support, 1 module, straight outlet, type F

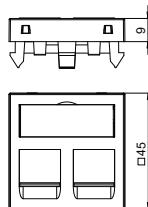

Type	Colour	Pack. pcs	Weight kg/100 pcs.	Item No.
DTG-2F RW1	Pure white	1	1.100	6119220
DTG-2F SWGR1	Black-grey	1	1.100	6119222
DTG-2F AL1	Aluminium painted	1	1.100	6119224

PC Polycarbonate

Data technology support with straight outlet and locking slider to accept two data technology connection modules. The locking fastening is suitable for horizontal and vertical installation in the system environment.

The type F data technology support is suitable for accepting the following data connection modules: Avaya/Systemax: M series.



Data technology support, 1 module, slanting outlet, type F

Type	Colour	Pack. pcs	Weight		Item No.
			kg/100	pcs.	
DTS-2F RW1	Pure white	1	1.500		6119256
DTS-2F SWGR1	Black-grey	1	1.500		6119258
DTS-2F AL1	Aluminium painted	1	1.500		6119260

PC Polycarbonate

Data technology support with slanting outlet and locking slider to accept two data technology connection modules with RJ45 socket. The locking fastening is suitable for horizontal and vertical installation in the system environment. Type F has a special module seat and is designed for indirect fastening of the data connection modules in the mounting opening.

The type F data technology support is suitable for accepting the following data connection modules: Avaya/Systimax: M series.

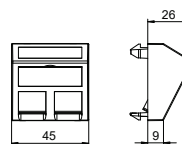

Data technology support, 1 module, straight outlet, type PA

Type	Colour	Pack. pcs	Weight		Item No.
			kg/100	pcs.	
DTG-2PA RW1	Pure white	1	1.100		6119226
DTG-2PA SWGR1	Black-grey	1	1.100		6119228
DTG-2PA AL1	Aluminium painted	1	1.100		6119230

PC Polycarbonate

Data technology support with straight outlet and locking slider to accept two data technology connection modules with RJ45 socket. The locking fastening is suitable for horizontal and vertical installation in the system environment. Type PA has a special module seat and is designed for indirect fastening of the data connection modules in the mounting opening.

The type PA data technology support is suitable for accepting the following data connection modules: Panduit: Mini-Com.

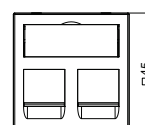
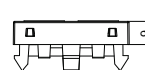

Data technology support, 1 module, slanting outlet, type PA

Type	Colour	Pack. pcs	Weight		Item No.
			kg/100	pcs.	
DTS-2PA RW1	Pure white	1	1.500		6119262
DTS-2PA SWGR1	Black-grey	1	1.500		6119264
DTS-2PA AL1	Aluminium painted	1	1.500		6119266

PC Polycarbonate

Data technology support with slanting outlet and locking slider to accept two data technology connection modules with RJ45 socket. The locking fastening is suitable for horizontal and vertical installation in the system environment. Type PA has a special module seat and is designed for indirect fastening of the data connection modules in the mounting opening.

The type PA data technology support is suitable for accepting the following data connection modules: Panduit: Mini-Com.

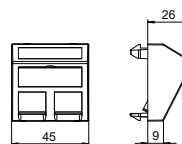

Data technology support, 1 module, straight outlet, type RM

Type	Colour	Pack. pcs	Weight		Item No.
			kg/100	pcs.	
DTG-2RM RW1	Pure white	1	1.100		6119292
DTG-2RM SWGR1	Black-grey	1	1.100		6119294
DTG-2RM AL1	Aluminium painted	1	1.100		6119296

PC Polycarbonate

Data technology support with straight outlet and locking slider to accept two data technology connection modules with RJ45 socket. The locking fastening is suitable for horizontal and vertical installation in the system environment. Type RM has a special module seat and is designed for indirect fastening of the data connection modules in the mounting opening.

The type RM data technology support is suitable for accepting the following data connection modules: Types ASM-C5, ASM-C5 G, ASM-C6 and ASM-C6 G; R&M: Cat.5 and Cat.6 modules without support plate.

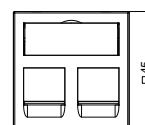
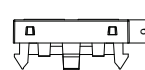

Data technology support, 1 module, slanting outlet, type RM

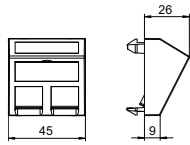

Type	Colour	Pack.	Weight	Item No.
		pcs	kg/100 pcs.	
DTS-2RM RW1	Pure white	1	2.900	6119298
DTS-2RM SWGR1	Black-grey	1	2.900	6119300
DTS-2RM AL1	Aluminium painted	1	2.900	6119302

PC Polycarbonate

Data technology support with slanting outlet and locking slider to accept two data technology connection modules with RJ45 socket. The locking fastening is suitable for horizontal and vertical installation in the system environment. Type RM has a special module seat and is designed for indirect fastening of the data connection modules in the mounting opening.

The type RM data technology support is suitable for accepting the following data connection modules: Types ASM-C5, ASM-C5 G, ASM-C6 and ASM-C6 G; R&M: Cat.5 and Cat.6 modules without support plate.

Data technology support, 1 module, straight outlet, type LE

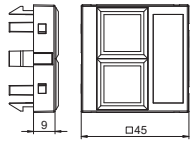

Type	Colour	Pack.	Weight	Item No.
		pcs	kg/100 pcs.	
DTG-02LE RW1	Pure white	1	0.900	6119304
DTG-02LE SWGR1	Black-grey	1	0.900	6119306
DTG-02LE AL1	Aluminium painted	1	0.900	6119308

PC Polycarbonate

Data technology support with straight outlet and without a locking slider to accept two data technology connection modules with RJ45 socket. The locking fastening is suitable for horizontal and vertical installation in the system environment. Type LE has a special module seat and is designed for indirect fastening of the data connection modules in the mounting opening.

The type LE data technology support is suitable for accepting the following data connection modules: LexCom/Schneider: LexCom 125, LexCom 250 and LexCom 500.



Multimedia support for VGA / D-Sub9 plug connector, 1 module, straight outlet

Type	Colour	Pack. pcs	Weight kg/100 pcs.	Item No.
MTG-DB O RW1	Pure white	1	0.700	6104706
MTG-DB O SWGR1	Black-grey	1	0.700	6104709
MTG-DB O AL1	Aluminium painted	1	0.700	6104712

PC Polycarbonate

Multimedia support for a VGA / D-Sub9 plug connector, straight cable outlet, with labelling panel, without plug connector. Support plate with locking fastening, suitable for horizontal and vertical installation in the system environment.

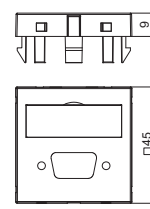

Multimedia support for VGA / D-Sub9 plug connector, 1 module, slanting outlet

Type	Colour	Pack. pcs	Weight kg/100 pcs.	Item No.
MTS-DB O RW1	Pure white	1	0.900	6104718
MTS-DB O SWGR1	Black-grey	1	0.900	6104721
MTS-DB O AL1	Aluminium painted	1	0.900	6104724

PC Polycarbonate

Multimedia support for a VGA / D-Sub9 plug connector, slanting cable outlet, with labelling panel, without plug connector. Support plate with locking fastening, suitable for horizontal and vertical installation in the system environment.

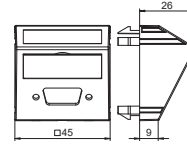

Multimedia support for DVI plug connector, 1 module, straight outlet

Type	Colour	Pack. pcs	Weight kg/100 pcs.	Item No.
MTG-DV O RW1	Pure white	1	0.700	6104778
MTG-DV O SWGR1	Black-grey	1	0.700	6104781
MTG-DV O AL1	Aluminium painted	1	0.700	6104784

PC Polycarbonate

Multimedia support for a DVI plug connector, straight cable outlet, with labelling panel, without plug connector. Support plate with locking fastening, suitable for horizontal and vertical installation in the system environment.

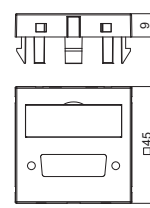

Multimedia support for DVI plug connector, 1 module, slanting outlet

Type	Colour	Pack. pcs	Weight kg/100 pcs.	Item No.
MTS-DV O RW1	Pure white	1	0.900	6104790
MTS-DV O SWGR1	Black-grey	1	0.900	6104793
MTS-DV O AL1	Aluminium painted	1	0.900	6104796

PC Polycarbonate

Multimedia support for a DVI plug connector, slanting cable outlet, with labelling panel, without plug connector. Support plate with locking fastening, suitable for horizontal and vertical installation in the system environment.

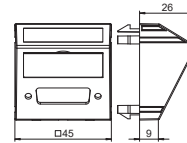

Multimedia support for SLR plug connector, 1 module, straight outlet

Type	Colour	Pack. pcs	Weight kg/100 pcs.	Item No.
MTG-X O RW1	Pure white	1	0.600	6105234
MTG-X O SWGR1	Black-grey	1	0.600	6105237
MTG-X O AL1	Aluminium painted	1	0.600	6105240

PC Polycarbonate

Multimedia support for a XLR plug connector, straight cable outlet, without labelling panel, without plug connector. Support plate with locking fastening, suitable for horizontal and vertical installation in the system environment.

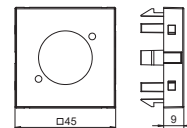

07_EGS_Produnkteilheitenkatalog_EX_2018 / en / 2018/10/08 08:19:15 08:19:15 (LLE:export_02229) / 2018/10/08 08:22:22 08:22:22

Modul 45® devices



D-Sub9 connection, 1 module, straight outlet, as screw connection

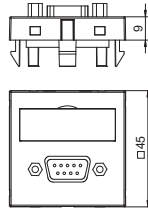

Type	Colour	Pack. pcs	Weight kg/100 pcs.	Item No.
MTG-DB9 S RW1	Pure white	1	2.400	6104634
MTG-DB9 S SWGR1	Black-grey	1	2.400	6104637
MTG-DB9 S AL1	Aluminium painted	1	2.400	6104640

PC Polycarbonate

Multimedia support with one D-Sub9 connection socket, straight cable outlet, with labelling panel, D-Sub9 socket (RS232) with screw connection. Support plate with locking fastening, suitable for horizontal and vertical installation in the system environment.

D-Sub9 connection, 1 module, slanting outlet, as screw connection

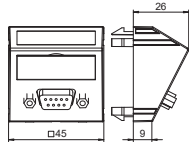

Type	Colour	Pack. pcs	Weight kg/100 pcs.	Item No.
MTS-DB9 S RW1	Pure white	1	2.600	6104646
MTS-DB9 S SWGR1	Black-grey	1	2.600	6104649
MTS-DB9 S AL1	Aluminium painted	1	2.600	6104652

PC Polycarbonate

Multimedia support with one D-Sub9 connection socket, slanting cable outlet, with labelling panel, D-Sub9 socket (RS232) with screw connection. Support plate with locking fastening, suitable for horizontal and vertical installation in the system environment.

D-Sub9 connection, 1 module, straight outlet, with connection cable

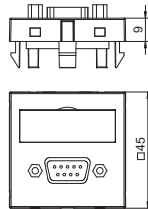

Type	Colour	Pack. pcs	Weight kg/100 pcs.	Item No.
MTG-DB9 F RW1	Pure white	1	5.200	6104682
MTG-DB9 F SWGR1	Black-grey	1	5.200	6104685
MTG-DB9 F AL1	Aluminium painted	1	5.200	6104688

PC Polycarbonate

Multimedia support with one D-Sub9 connection socket, straight cable outlet, with labelling panel, short D-Sub9 connection cable (RS232), socket-socket version. Support with locking fastening, suitable for horizontal and vertical installation in the system environment.

D-Sub9 connection, 1 module, slanting outlet, with connection cable

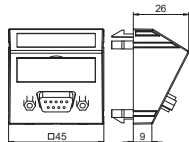

Type	Colour	Pack. pcs	Weight kg/100 pcs.	Item No.
MTS-DB9 F RW1	Pure white	1	5.400	6104694
MTS-DB9 F SWGR1	Black-grey	1	5.400	6104697
MTS-DB9 F AL1	Aluminium painted	1	5.400	6104700

PC Polycarbonate

Multimedia support with one D-Sub9 connection socket, slanting cable outlet, with labelling panel, short D-Sub9 connection cable (RS232), socket-socket version. Support with locking fastening, suitable for horizontal and vertical installation in the system environment.

USB 2.0 / 3.0 connection, 1 module, straight outlet, as screw connection

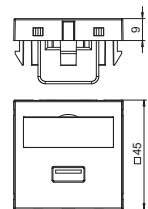

Type	Colour	Pack. pcs	Weight kg/100 pcs.	Item No.
MTG-U3A S RW1	Pure white	1	2.500	6104874
MTG-U3A S SWGR1	Black-grey	1	2.500	6104877
MTG-U3A S AL1	Aluminium painted	1	2.500	6104880

PC Polycarbonate

Multimedia support with one USB 3.0 connection socket, straight cable outlet, with labelling panel, USB 3.0 Type A socket with screw connection. Support plate with locking fastening, suitable for horizontal and vertical installation in the system environment.

USB 2.0 / 3.0 connection, 1 module, slanting outlet, as screw connection

Type	Colour	Pack. pcs	Weight kg/100 pcs.	Item No.
MTS-U3A S RW1	Pure white	1	2.700	6104886
MTS-U3A S SWGR1	Black-grey	1	2.700	6104889
MTS-U3A S AL1	Aluminium painted	1	2.700	6104892

PC Polycarbonate

Multimedia support with one USB 3.0 connection socket, slanting cable outlet, with labelling panel, USB 3.0 type A socket with screw connection. Support plate with locking fastening, suitable for horizontal and vertical installation in the system environment.

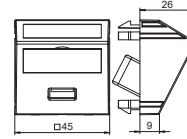

USB 2.0 / 3.0 connection, 1 module, straight outlet, with connection cable

Type	Colour	Pack. pcs	Weight kg/100 pcs.	Item No.
MTG-U3A F RW1	Pure white	1	6.000	6104922
MTG-U3A F SWGR1	Black-grey	1	6.000	6104925
MTG-U3A F AL1	Aluminium painted	1	6.000	6104928

PC Polycarbonate

Multimedia support with one USB 3.0 connection socket, straight cable outlet, with labelling panel, short USB 3.0 type A connection cable, socket-socket version. Support plate with locking fastening, suitable for horizontal and vertical installation in the system environment.

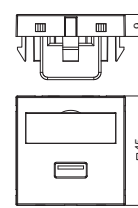

USB 2.0 / 3.0 connection, 1 module, slanting outlet, with connection cable

Type	Colour	Pack. pcs	Weight kg/100 pcs.	Item No.
MTS-U3A F RW1	Pure white	1	6.200	6104934
MTS-U3A F SWGR1	Black-grey	1	6.200	6104937
MTS-U3A F AL1	Aluminium painted	1	6.200	6104940

PC Polycarbonate

Multimedia support with one USB 3.0 connection socket, slanting cable outlet, with labelling panel, short USB 3.0 type A connection cable, socket-socket version. Support plate with locking fastening, suitable for horizontal and vertical installation in the system environment.

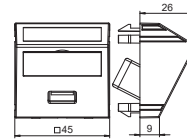

07_EGS_Produnkteilheitenkatalog_EX_2018 / en / 2018/10/08 08:19:15 08:19:15 (LLEExport_02229) / 2018/10/08 08:22:22 08:22:22

Modul 45® devices



DVI-D connection, 1 module, straight outlet, as screw connection

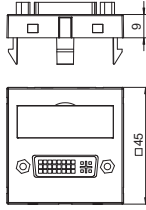

Type	Colour	Pack. pcs	Weight kg/100 pcs.	Item No.
MTG-DVI S RW1	Pure white	1	3.500	6104730
MTG-DVI S SWGR1	Black-grey	1	3.500	6104733
MTG-DVI S AL1	Aluminium painted	1	3.500	6104736

PC Polycarbonate

Multimedia support with one DVI-D connection socket, straight cable outlet, with labelling panel, DVI-D socket with screw connection. Support plate with locking fastening, suitable for horizontal and vertical installation in the system environment.

Note: Due to the device dimensions, device installation in Rapid 45 device installation trunking is not possible.

DVI-D connection, 1 module, slanting outlet, as screw connection

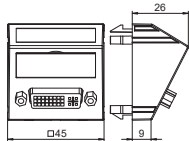

Type	Colour	Pack. pcs	Weight kg/100 pcs.	Item No.
MTS-DVI S RW1	Pure white	1	3.700	6104742
MTS-DVI S SWGR1	Black-grey	1	3.700	6104745
MTS-DVI S AL1	Aluminium painted	1	3.700	6104748

PC Polycarbonate

Multimedia support with one DVI-D connection socket, slanting cable outlet, with labelling panel, DVI-D socket with screw connection. Support plate with locking fastening, suitable for horizontal and vertical installation in the system environment.

DVI-I connection, 1 module, straight outlet, with connection cable

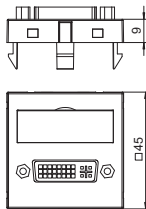

Type	Colour	Pack. pcs	Weight kg/100 pcs.	Item No.
MTG-DVI F RW1	Pure white	1	6.000	6104754
MTG-DVI F SWGR1	Black-grey	1	6.000	6104757
MTG-DVI F AL1	Aluminium painted	1	6.000	6104760

PC Polycarbonate

Multimedia support with one DVI-I connection socket, straight cable outlet, with labelling panel, short DVI-I connection cable, socket-socket version. Support with locking fastening, suitable for horizontal and vertical installation in the system environment.

DVI-I connection, 1 module, slanting outlet, with connection cable

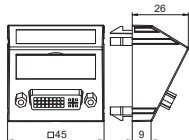

Type	Colour	Pack. pcs	Weight kg/100 pcs.	Item No.
MTS-DVI F RW1	Pure white	1	6.200	6104766
MTS-DVI F SWGR1	Black-grey	1	6.200	6104769
MTS-DVI F AL1	Aluminium painted	1	6.200	6104772

PC Polycarbonate

Multimedia support with one DVI-I connection socket, slanting cable outlet, with labelling panel, short DVI-I connection cable, socket-socket version. Support with locking fastening, suitable for horizontal and vertical installation in the system environment.

HDMI connection, 1 module, straight outlet, as screw connection

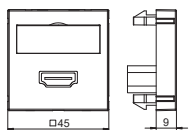

Type	Colour	Pack. pcs	Weight kg/100 pcs.	Item No.
MTG-HD S RW1	Pure white	1	3.200	6104802
MTG-HD S SWGR1	Black-grey	1	3.200	6104805
MTG-HD S AL1	Aluminium painted	1	3.200	6104808

PC Polycarbonate

Multimedia support with one HDMI connection socket, straight cable outlet, with labelling panel, HDMI socket with screw connection. Support plate with locking fastening, suitable for horizontal and vertical installation in the system environment.

Note: Due to the device dimensions, device installation in Rapid 45 device installation ducts and ISSR..45 / ISSD..45 service poles is not possible.



HDMI connection, 1 module, slanting outlet, as screw connection

Type	Colour	Pack. pcs	Weight		Item No.
			kg/100	pcs.	
MTS-HD S RW1	Pure white	1	3.400		6104814
MTS-HD S SWGR1	Black-grey	1	3.400		6104817
MTS-HD S AL1	Aluminium painted	1	3.400		6104820

PC Polycarbonate

Multimedia support with one HDMI connection socket, slanting cable outlet, with labelling panel, HDMI socket with screw connection. Support plate with locking fastening, suitable for horizontal and vertical installation in the system environment.

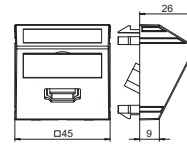

HDMI connection, 1 module, straight outlet, with connection cable

Type	Colour	Pack. pcs	Weight		Item No.
			kg/100	pcs.	
MTG-HD F RW1	Pure white	1	6.000		6104826
MTG-HD F SWGR1	Black-grey	1	6.000		6104829
MTG-HD F AL1	Aluminium painted	1	6.000		6104832

PC Polycarbonate

Multimedia support with one HDMI connection socket, straight cable outlet, with labelling panel, short HDMI connection cable, socket-socket version. Support plate with locking fastening, suitable for horizontal and vertical installation in the system environment.

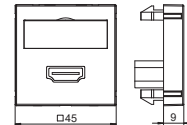

HDMI connection, 1 module, slanting outlet, with connection cable

Type	Colour	Pack. pcs	Weight		Item No.
			kg/100	pcs.	
MTS-HD F RW1	Pure white	1	6.200		6104838
MTS-HD F SWGR1	Black-grey	1	6.200		6104841
MTS-HD F AL1	Aluminium painted	1	6.200		6104844

PC Polycarbonate

Multimedia support with one HDMI connection socket, slanting cable outlet, with labelling panel, short HDMI connection cable, socket-socket version. Support plate with locking fastening, suitable for horizontal and vertical installation in the system environment.

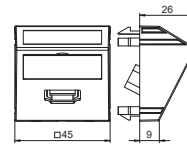

VGA connection, 1 module, straight outlet, as screw connection

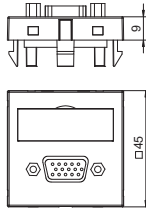

Type	Colour	Pack. pcs	Weight kg/100 pcs.	Item No.
MTG-VGA S RW1	Pure white	1	2.400	6104610
MTG-VGA S SWGR1	Black-grey	1	2.400	6104613
MTG-VGA S AL1	Aluminium painted	1	2.400	6104616

PC Polycarbonate

Multimedia support with one VGA connection socket, straight cable outlet, with labelling panel, VGA socket (HD15) with screw connection. Support plate with locking fastening, suitable for horizontal and vertical installation in the system environment.

VGA connection, 1 module, slanting outlet, as screw connection

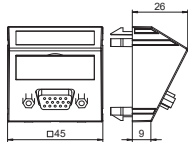

Type	Colour	Pack. pcs	Weight kg/100 pcs.	Item No.
MTS-VGA S RW1	Pure white	1	2.600	6104622
MTS-VGA S SWGR1	Black-grey	1	2.600	6104625
MTS-VGA S AL1	Aluminium painted	1	2.600	6104628

PC Polycarbonate

Multimedia support with one VGA connection socket, slanting cable outlet, with labelling panel, VGA socket (HD15) with screw connection. Support plate with locking fastening, suitable for horizontal and vertical installation in the system environment.

VGA connection, 1 module, straight outlet, with connection cable

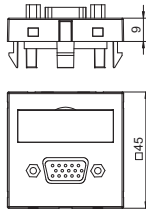

Type	Colour	Pack. pcs	Weight kg/100 pcs.	Item No.
MTG-VGA F RW1	Pure white	1	5.200	6104658
MTG-VGA F SWGR1	Black-grey	1	5.200	6104661
MTG-VGA F AL1	Aluminium painted	1	5.200	6104664

PC Polycarbonate

Multimedia support with one VGA connection socket, straight cable outlet, with labelling panel, short VGA connection cable (HD15), socket-socket version. Support with locking fastening, suitable for horizontal and vertical installation in the system environment.

VGA connection, 1 module, slanting outlet, with connection cable

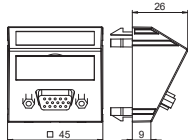

Type	Colour	Pack. pcs	Weight kg/100 pcs.	Item No.
MTS-VGA F RW1	Pure white	1	5.400	6104670
MTS-VGA F SWGR1	Black-grey	1	5.400	6104673
MTS-VGA F AL1	Aluminium painted	1	5.400	6104676

PC Polycarbonate

Multimedia support with one VGA connection socket, slanting cable outlet, with labelling panel, short VGA connection cable (HD15), socket-socket version. Support with locking fastening, suitable for horizontal and vertical installation in the system environment.

Mini jack connection, 1 module, straight outlet, as soldered connection

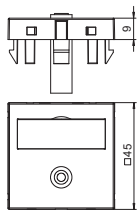

Type	Colour	Pack. pcs	Weight kg/100 pcs.	Item No.
MTG-MK L RW1	Pure white	1	1.500	6104946
MTG-MK L SWGR1	Black-grey	1	1.500	6104949
MTG-MK L AL1	Aluminium painted	1	1.500	6104952

PC Polycarbonate

Multimedia support with one mini jack connection socket, straight cable outlet, with labelling panel, mini cinch socket (TRS 3.5 mm) with soldered connection. Support plate with locking fastening, suitable for horizontal and vertical installation in the system environment.

Mini jack connection, 1 module, slanting outlet, as soldered connection

Type	Colour	Pack. pcs	Weight kg/100 pcs.	Item No.
MTS-MK L RW1	Pure white	1	1.700	6104958
MTS-MK L SWGR1	Black-grey	1	1.700	6104961
MTS-MK L AL1	Aluminium painted	1	1.700	6104964

PC Polycarbonate

Multimedia support with one mini jack connection socket, slanting cable outlet, with labelling panel, mini cinch socket (TRS 3.5 mm) with soldered connection. Support plate with locking fastening, suitable for horizontal and vertical installation in the system environment.

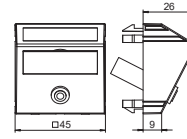

Video cinch connection, 1 module, straight outlet, as soldered connection

Type	Colour	Pack. pcs	Weight kg/100 pcs.	Item No.
MTG-R L RW1	Pure white	1	1.500	6104970
MTG-R L SWGR1	Black-grey	1	1.500	6104973
MTG-R L AL1	Aluminium painted	1	1.500	6104976

PC Polycarbonate

Multimedia support with one cinch connection socket for composite video, straight cable outlet, with labelling panel, cinch socket (RCA) with soldered connection, colour coding yellow. Support plate with locking fastening, suitable for horizontal and vertical installation in the system environment.

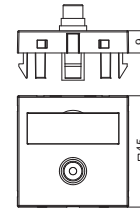

Video cinch connection, 1 module, slanting outlet, as soldered connection

Type	Colour	Pack. pcs	Weight kg/100 pcs.	Item No.
MTS-R L RW1	Pure white	1	1.700	6104982
MTS-R L SWGR1	Black-grey	1	1.700	6104985
MTS-R L AL1	Aluminium painted	1	1.700	6104988

PC Polycarbonate

Multimedia support with one cinch connection socket for composite video, slanting cable outlet, with labelling panel, cinch socket (RCA) with soldered connection, colour coding yellow. Support plate with locking fastening, suitable for horizontal and vertical installation in the system environment.

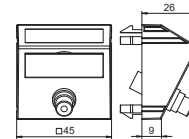

Video cinch connection, 1 module, straight outlet, as 1:1 coupling

Type	Colour	Pack. pcs	Weight kg/100 pcs.	Item No.
MTG-R F RW1	Pure white	1	1.500	6104994
MTG-R F SWGR1	Black-grey	1	1.500	6104997

PC Polycarbonate

Multimedia support with one cinch connection socket for composite video, straight cable outlet, with labelling panel, cinch coupling (RCA), socket-socket version, colour coding yellow. Support plate with locking fastening, suitable for horizontal and vertical installation in the system environment.

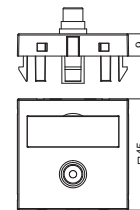

Video cinch connection, 1 module, slanting outlet, as 1:1 coupling

Type	Colour	Pack. pcs	Weight kg/100 pcs.	Item No.
MTS-R F RW1	Pure white	1	1.700	6105006
MTS-R F SWGR1	Black-grey	1	1.700	6105009
MTS-R F AL1	Aluminium painted	1	1.700	6105012

PC Polycarbonate

Multimedia support with one cinch connection socket for composite video, slanting cable outlet, with labelling panel, cinch coupling (RCA), socket-socket version, colour coding yellow. Support plate with locking fastening, suitable for horizontal and vertical installation in the system environment.

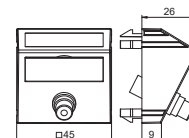

07_EGS_Produnkteilheitenkatalog_EX_2018 / en / 2018/10/08 08:19:15 08:19:15 (LLEExport_02229) / 2018/10/08 08:22:22 08:22:22

Modul 45® devices

Audio cinch connection, 1 module, straight outlet, as soldered connection

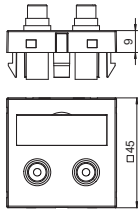

Type	Colour	Pack. pcs	Weight kg/100 pcs.	Item No.
MTG-2R L RW1	Pure white	1	2.500	6105042
MTG-2R L SWGR1	Black-grey	1	2.500	6105045
MTG-2R L AL1	Aluminium painted	1	2.500	6105048

PC Polycarbonate

Multimedia support with two cinch connection sockets for audio R/L, straight cable outlet, with labelling panel, two cinch sockets (RCA) with soldered connection, colour coding red/white. Support plate with locking fastening, suitable for horizontal and vertical installation in the system environment.

Audio cinch connection, 1 module, slanting outlet, as soldered connection

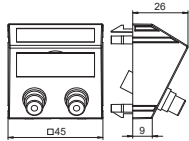

Type	Colour	Pack. pcs	Weight kg/100 pcs.	Item No.
MTS-2R L RW1	Pure white	1	2.700	6105054
MTS-2R L SWGR1	Black-grey	1	2.700	6105057
MTS-2R L AL1	Aluminium painted	1	2.700	6105060

PC Polycarbonate

Multimedia support with two cinch connection sockets for audio R/L, slanting cable outlet, with labelling panel, two cinch sockets (RCA) with soldered connection, colour coding red/white. Support plate with locking fastening, suitable for horizontal and vertical installation in the system environment.

Audio cinch connection, 1 module, straight outlet, as 1:1 coupling

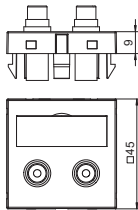

Type	Colour	Pack. pcs	Weight kg/100 pcs.	Item No.
MTG-2R F RW1	Pure white	1	2.500	6105066
MTG-2R F SWGR1	Black-grey	1	2.500	6105069
MTG-2R F AL1	Aluminium painted	1	2.500	6105072

PC Polycarbonate

Multimedia support with two cinch connection sockets for audio R/L, straight cable outlet, with labelling panel, two cinch couplings (RCA), socket-socket version, colour coding red/white. Support plate with locking fastening, suitable for horizontal and vertical installation in the system environment.

Audio cinch connection, 1 module, slanting outlet, as 1:1 coupling

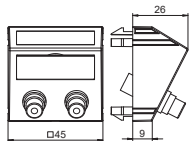

Type	Colour	Pack. pcs	Weight kg/100 pcs.	Item No.
MTS-2R F RW1	Pure white	1	2.700	6105078
MTS-2R F SWGR1	Black-grey	1	2.700	6105081
MTS-2R F AL1	Aluminium painted	1	2.700	6105084

PC Polycarbonate

Multimedia support with two cinch connection sockets for audio R/L, slanting cable outlet, with labelling panel, two cinch couplings (RCA), socket-socket version, colour coding red/white. Support plate with locking fastening, suitable for horizontal and vertical installation in the system environment.

Component video connection, 1 module, straight outlet, as soldered connection

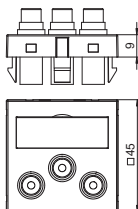

Type	Colour	Pack. pcs	Weight kg/100 pcs.	Item No.
MTG-3R L RW1	Pure white	1	3.200	6105114
MTG-3R L SWGR1	Black-grey	1	3.200	6105117
MTG-3R L AL1	Aluminium painted	1	3.200	6105120

PC Polycarbonate

Multimedia support with three cinch connection sockets for component video, straight cable outlet, with labelling panel, three cinch sockets (RCA) with soldered connection, colour coding red / green / blue. Support plate with locking fastening, suitable for horizontal and vertical installation in the system environment.



Component video connection, 1 module, slanting outlet, as soldered connection

Type	Colour	Pack. pcs	Weight kg/100 pcs.	Item No.
MTS-3R L RW1	Pure white	1	3.400	6105126
MTS-3R L SWGR1	Black-grey	1	3.400	6105129
MTS-3R L AL1	Aluminium painted	1	3.400	6105132

PC Polycarbonate

Multimedia support with three cinch connection sockets for component video, slanting cable outlet, with labelling panel, three cinch sockets (RCA) with soldered connection, colour coding red / green / blue. Support plate with locking fastening, suitable for horizontal and vertical installation in the system environment.

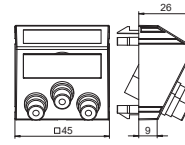

Component video connection, 1 module, straight outlet, as 1:1 coupling

Type	Colour	Pack. pcs	Weight kg/100 pcs.	Item No.
MTG-3R F RW1	Pure white	1	3.200	6105138
MTG-3R F SWGR1	Black-grey	1	3.200	6105141
MTG-3R F AL1	Aluminium painted	1	3.200	6105144

PC Polycarbonate

Multimedia support with three cinch connection sockets for component video, straight cable outlet, with labelling panel, three cinch couplings (RCA), socket-socket version, colour coding red / green / blue. Support plate with locking fastening, suitable for horizontal and vertical installation in the system environment.

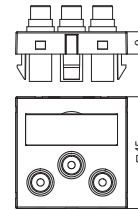

Component video connection, 1 module, slanting outlet, as 1:1 coupling

Type	Colour	Pack. pcs	Weight kg/100 pcs.	Item No.
MTS-3R F RW1	Pure white	1	3.400	6105150
MTS-3R F SWGR1	Black-grey	1	3.400	6105153
MTS-3R F AL1	Aluminium painted	1	3.400	6105156

PC Polycarbonate

Multimedia support with three cinch connection sockets for component video, slanting cable outlet, with labelling panel, three cinch couplings (RCA), socket-socket version, colour coding red / green / blue. Support plate with locking fastening, suitable for horizontal and vertical installation in the system environment.

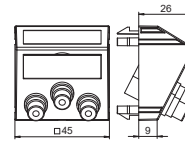

Audio/video cinch connection, 1 module, straight outlet, as soldered connection

Type	Colour	Pack. pcs	Weight kg/100 pcs.	Item No.
MTG-12R L RW1	Pure white	1	3.200	6105162
MTG-12R L SWGR1	Black-grey	1	3.200	6105165
MTG-12R L AL1	Aluminium painted	1	3.200	6105168

PC Polycarbonate

Multimedia support with three cinch connection sockets for audio-video, straight cable outlet, with labelling panel, three cinch sockets (RCA) with soldered connection, colour coding yellow / red / white. Support plate with locking fastening, suitable for horizontal and vertical installation in the system environment.

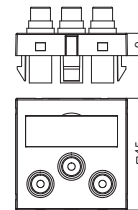

07_EGS_Produnkteilheitenkatalog_EX_2018 / en / 2018/10/08 08:19:15 08:19:15 (LLExport_02229) / 2018/10/08 08:22:22 08:22:22

Modul 45® devices

Audio/video cinch connection, 1 module, slanting outlet, as soldered connection

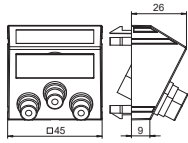

Type	Colour	Pack. pcs	Weight kg/100 pcs.	Item No.
MTS-12R L RW1	Pure white	1	3.400	6105174
MTS-12R L SWGR1	Black-grey	1	3.400	6105177
MTS-12R L AL1	Aluminium painted	1	3.400	6105180

PC Polycarbonate

Multimedia support with three cinch connection sockets for audio/video, slanting cable outlet, with labelling panel, three cinch sockets (RCA) with soldered connection, colour coding yellow / red / white. Support plate with locking fastening, suitable for horizontal and vertical installation in the system environment.

Audio/video cinch connection, 1 module, straight outlet, as 1:1 coupling

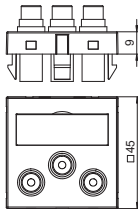

Type	Colour	Pack. pcs	Weight kg/100 pcs.	Item No.
MTG-12R F RW1	Pure white	1	3.200	6105186
MTG-12R F SWGR1	Black-grey	1	3.200	6105189
MTG-12R F AL1	Aluminium painted	1	3.200	6105192

PC Polycarbonate

Multimedia support with three cinch connection sockets for audio/video, straight cable outlet, with labelling panel, three cinch couplings (RCA), socket-socket version, colour coding yellow / red / white. Support plate with locking fastening, suitable for horizontal and vertical installation in the system environment.

Audio/video cinch connection, 1 module, slanting outlet, as 1:1 coupling

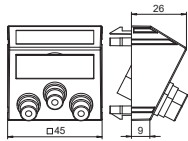

Type	Colour	Pack. pcs	Weight kg/100 pcs.	Item No.
MTS-12R F RW1	Pure white	1	3.400	6105198
MTS-12R F SWGR1	Black-grey	1	3.400	6105201
MTS-12R F AL1	Aluminium painted	1	3.400	6105204

PC Polycarbonate

Multimedia support with three cinch connection sockets for audio/video, slanting cable outlet, with labelling panel, three cinch couplings (RCA), socket-socket version, colour coding yellow / red / white. Support plate with locking fastening, suitable for horizontal and vertical installation in the system environment.

XLR connection, 1 module, straight outlet, 3-pin socket, as soldered connection

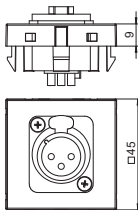

Type	Colour	Pack. pcs	Weight kg/100 pcs.	Item No.
MTG-X3F L RW1	Pure white	1	3.000	6105210
MTG-X3F L SWGR1	Black-grey	1	3.000	6105213
MTG-X3F L AL1	Aluminium painted	1	3.000	6105216

PC Polycarbonate

Multimedia support with one XLR connection socket, straight cable outlet, without labelling panel, 3-pin XLR socket with soldered connection. Support plate with locking fastening, suitable for horizontal and vertical installation in the system environment.

XLR connection, 1 module, straight outlet, 3-pin connector, as soldered connection

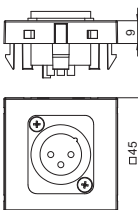

Type	Colour	Pack. pcs	Weight kg/100 pcs.	Item No.
MTG-X3M L RW1	Pure white	1	3.000	6105222
MTG-X3M L SWGR1	Black-grey	1	3.000	6105225
MTG-X3M L AL1	Aluminium painted	1	3.000	6105228

PC Polycarbonate

Multimedia support with one XLR connection socket, straight cable outlet, without labelling panel, 3-pin XLR connector with soldered connection. Support plate with locking fastening, suitable for horizontal and vertical installation in the system environment.

XLR connection, 1 module, straight outlet, 3-pin socket, as screw connection

Type	Colour	Pack. pcs	Weight kg/100 pcs.	Item No.
MTG-X3F S RW1	Pure white	1	3.500	6105250
MTG-X3F S SWGR1	Black-grey	1	3.500	6105252
MTG-X3F S AL1	Aluminium painted	1	3.500	6105254

PC Polycarbonate

Multimedia support with one XLR connection socket, straight cable outlet, without labelling panel, XLR 3-pin socket with screw connection. Support plate with locking fastening, suitable for horizontal and vertical installation in the system environment.

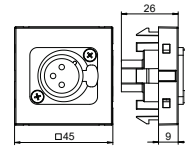

XLR connection, 1 module, straight outlet, 3-pin connection, as screw connection

Type	Colour	Pack. pcs	Weight kg/100 pcs.	Item No.
MTG-X3M S RW1	Pure white	1	3.500	6105258
MTG-X3M S SWGR1	Black-grey	1	3.500	6105260
MTG-X3M S AL1	Aluminium painted	1	3.500	6105262

PC Polycarbonate

Multimedia support with one XLR connection socket, straight cable outlet, without labelling panel, XLR 3-pin socket with screw connection. Support plate with locking fastening, suitable for horizontal and vertical installation in the system environment.

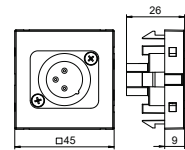

Speakon connection, 1 module, straight outlet, 4-pin socket, as screw connection

Type	Colour	Pack. pcs	Weight kg/100 pcs.	Item No.
MTG-SON S RW1	Pure white	1	2.800	6105270
MTG-SON S SWGR1	Black-grey	1	2.800	6105272
MTG-SON S AL1	Aluminium painted	1	2.800	6105274

PC Polycarbonate

Multimedia support with one Speakon connection socket, straight cable outlet, without labelling panel, Speakon 4-pin socket with screw connection. Support plate with locking fastening, suitable for horizontal and vertical installation in the system environment.

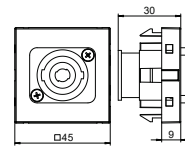

BNC connection, 1 module, straight outlet, as 1:1 coupling

Type	Colour	Pack. pcs	Weight kg/100 pcs.	Item No.
MTG-BC F RW1	Pure white	1	1.500	6105018
MTG-BC F SWGR1	Black-grey	1	1.500	6105021
MTG-BC F AL1	Aluminium painted	1	1.500	6105024

PC Polycarbonate

Multimedia support with one BNC connection socket, straight cable outlet, with labelling panel, BNC cinch coupling, socket-socket version. Support plate with locking fastening, suitable for horizontal and vertical installation in the system environment.

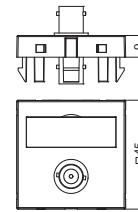

BNC connection, 1 module, slanting outlet, as 1:1 coupling

Type	Colour	Pack. pcs	Weight kg/100 pcs.	Item No.
MTS-BC F RW1	Pure white	1	1.700	6105030
MTS-BC F SWGR1	Black-grey	1	1.700	6105033
MTS-BC F AL1	Aluminium painted	1	1.700	6105036

PC Polycarbonate

Multimedia support with one BNC connection socket, slanting cable outlet, with labelling panel, BNC cinch coupling, socket-socket version. Support plate with locking fastening, suitable for horizontal and vertical installation in the system environment.

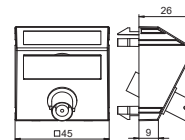

07_EGS_Produnkteilheitenkatalog_EX_2018 / en / 2018/10/08 08:19:15 08:19:15 (LLExport_02229) / 2018/10/08 08:22:22 08:22:22

Modul 45® devices

2x BNC connection, 1 module, straight outlet, as 1:1 coupling

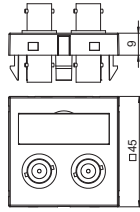

Type	Colour	Pack. pcs	Weight kg/100 pcs.	Item No.
MTG-2BC F RW1	Pure white	1	2.500	6105090
MTG-2BC F SWGR1	Black-grey	1	2.500	6105093
MTG-2BC F AL1	Aluminium painted	1	2.500	6105096

PC Polycarbonate

Multimedia support with two BNC connection sockets, straight cable outlet, with labelling panel, two BNC couplings, socket-socket version. Support plate with locking fastening, suitable for horizontal and vertical installation in the system environment.

2x BNC connection, 1 module, slanting outlet, as 1:1 coupling

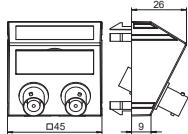

Type	Colour	Pack. pcs	Weight kg/100 pcs.	Item No.
MTS-2BC F RW1	Pure white	1	2.700	6105102
MTS-2BC F SWGR1	Black-grey	1	2.700	6105105
MTS-2BC F AL1	Aluminium painted	1	2.700	6105108

PC Polycarbonate

Multimedia support with two BNC connection sockets, slanting cable outlet, with labelling panel, two BNC couplings, socket-socket version. Support plate with locking fastening, suitable for horizontal and vertical installation in the system environment.

Antenna connection, 1 module, TV / radio / SAT, antenna socket

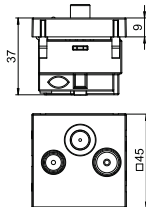

Type	Colour	Pack. pcs	Weight kg/100 pcs.	Item No.
ANT-3SD RW1	Pure white	1	11.596	6105282
ANT-3SD SWGR1	Black-grey	1	11.596	6105284
ANT-3SD AL1	Aluminium painted	1	11.000	6105286

PC Polycarbonate

Socket for antenna, BK and satellite reception systems with connection for TV and radio.

Frequency: 5–2150 MHz
 Heat attenuation: 5-862 MHz - 1 dB
 950-2150 MHz - 2 dB
 Return channel attenuation: 14 dB
 EMC protection class A

Equipotential bonding socket, 1 module, straight outlet

Type	Colour	Pack. pcs	Weight kg/100 pcs.	Item No.
PAD-ID6 RW1	Pure white	1	5.000	6120003
PAD-ID6 SWGR1	Black-grey	1	5.000	6120001
PAD-ID6 AL1	Aluminium painted	1	5.000	6120005

PC Polycarbonate

Equipotential bonding socket to DIN 42801, socket in black with green-yellow colour ring, cable connection to rear with M6 screw bolt, including two nuts, washers and a serrated washer.

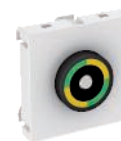
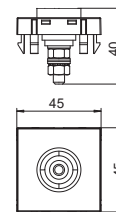

Cable outlet for 3–11 mm cross-section

Type	Colour	Pack. pcs	Weight kg/100 pcs.	Item No.
KAL-K11 RW1	Pure white	1	3.500	6117420
KAL-K11 SWGR1	Black-grey	1	3.500	6117421
KAL-K11 AL1	Aluminium painted	1	3.500	6117422

PC Polycarbonate

Two-part cable outlet with labelling panel, consisting of a cable support with strain relief and a cover. The strain relief is suited for cable cross-sections of 3 to 11 mm. The locking fastening is suitable for horizontal and vertical installation in the system environment.

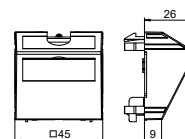

Blanking cover with labelling panel, 1/2 module

Type	Colour	Pack. pcs	Weight kg/100 pcs.	Item No.
ADP-BF RW0.5	Pure white	1	0.400	6117410
ADP-BF SWGR0.5	Black-grey	1	0.400	6117411
ADP-BF AL0.5	Aluminium painted	1	0.400	6117412

PC Polycarbonate

Blanking cover with labelling panel, suited for labelling devices in Rapid 45 device installation trunking systems and ISS service poles with a 45 mm system opening.

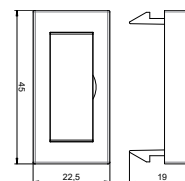

Blanking cover, 1/2 module

Type	Colour	Pack. pcs	Weight kg/100 pcs.	Item No.
ADP-B RW0.5	Pure white	10	0.400	6117414
ADP-B SWGR0.5	Black-grey	10	0.400	6117415
ADP-B AL0.5	Aluminium painted	1	0.400	6117416

Blanking lid for closing off empty spaces for a half device (1/2 module).

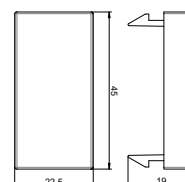

Blanking cover, 1 module

Type	Colour	Pack. pcs	Weight kg/100 pcs.	Item No.
ADP-B RW1	Pure white	10	0.800	6117406
ADP-B SWGR1	Black-grey	10	0.800	6117407
ADP-B AL1	Aluminium painted	1	0.800	6117408

Blanking lid for closing off empty spaces for a device (one module).

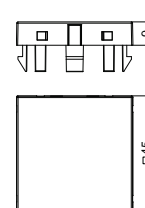

TAE telephone connection socket, 1 module, F version

Type	Colour	Pack. pcs	Weight kg/100 pcs.	Item No.
TAE-6F AL1	Aluminium painted	1	2.000	6117430

Telephone connection box TAE 6 F.

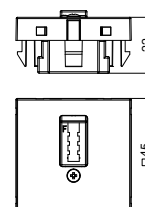

Surface-mounted housing



Modul 45® – device installation solutions for surface and concealed mounting

The Modul net set is designed for the installation of Modul 45 devices and can be used for surface-mounted or cavity wall installations. The installation housing, which has a modular structure, can also be easily adjusted to the required number of installation devices. The basic configuration offers space for 4 Modul 45 installation devices. The housing can be expanded as required using an expansion module for 2 Modul 45 installation devices.

For installations in cavity walls, matching cavity wall supports and screen frames are available as accessories. Installations with 4 devices (2x 2x) and 6 installation devices (3x 2x) are possible.



Cavity wall installation





Modul 45® – device installation solutions for surface and concealed mounting



Modul 45®, modal net installation housing

46



Modul 45®, Modal net surface-mounted housing

Surface-mounted housing, basic configuration, 2x double

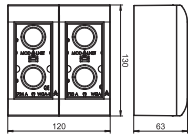

Type	Colour	Pack. Weight		Item No.
		pcs	kg/100 pcs.	
WG-AK RW	Pure white	1	35.000	6109900
PC Polycarbonate				

Basic configuration consisting of two housing bases (right and left side) with two cover frames to accept of Modul 45 accessories of 2x module width = 90 mm.

Surface-mounted housing, expansion module, double

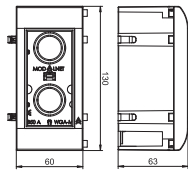

Type	Colour	Pack. Weight		Item No.
		pcs	kg/100 pcs.	
WG-MK RW	Pure white	1	17.500	6109905
PC Polycarbonate				

Extension module consisting of housing base and cover frame to accept Modul 45 accessories of 2x module width = 90 mm.

Cover frame, double, for protective equipment installation

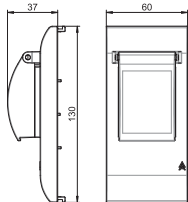

Type	Colour	Pack. Weight		Item No.
		pcs	kg/100 pcs.	
WG-AF2TE RW	Pure white	1	7.500	6109932
PC Polycarbonate				

Construction set, protection unit installation consisting of cover with mounting support and transparent cover hood. Allows the installation of protective equipment (two units) such as miniature circuit-breakers or FI protection switches in the Modal net housing.

Support for cavity wall installation 2x double

Type	Pack. pcs	Weight kg/100 pcs.	Item No.
WG-UK2	1	31.000	6109950

- St** Steel
- FS** Strip-galvanised

Metal cavity wall support to accept the Modal net housing double.

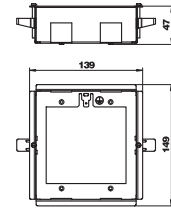

Screen frame for cavity wall installation 2x double

Type	Colour	Pack. pcs	Weight kg/100 pcs.	Item No.
WG-UBR2 RW	Pure white	1	4.400	6109934

- PC** Polycarbonate

Screen frame for placing on the cavity wall support double.

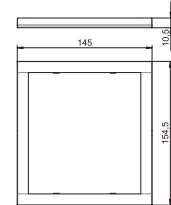

Support for cavity wall installation 3x double

Type	Pack. pcs	Weight kg/100 pcs.	Item No.
WG-UK3	1	35.000	6109952

- St** Steel
- FS** Strip-galvanised

Metal cavity wall support to accept the Modal net housing triple.

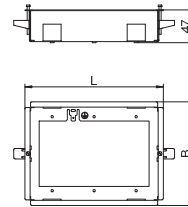

Screen frame for cavity wall installation 3x double

Type	Colour	Pack. pcs	Weight kg/100 pcs.	Item No.
WG-UBR3 RW	Pure white	1	4.500	6109936

- PC** Polycarbonate

Screen frame for placing on the cavity wall support triple.

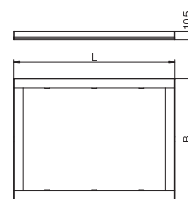

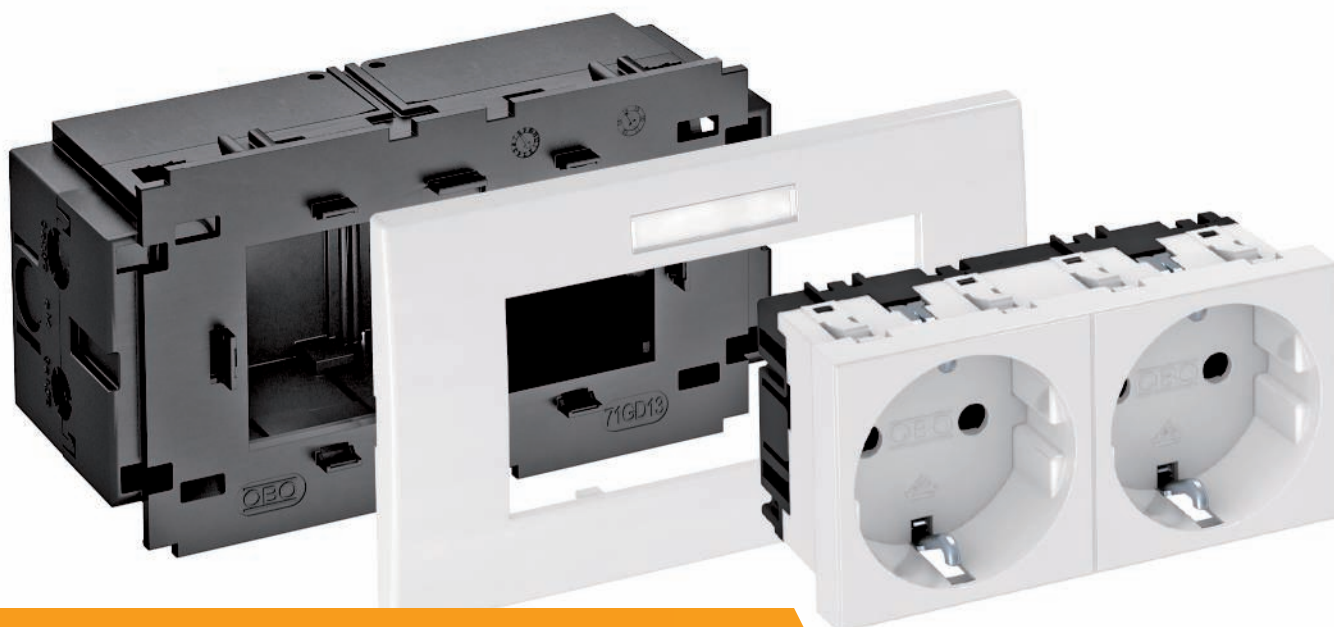

Modul 45® and standard – installation solutions for device installation trunking and service poles with 80 mm system opening

The Modul 45 devices from OBO Bettermann are compact and space-saving. They are therefore ideal for use in device installation trunking and service poles. The Modul 45 system makes optimum use of limited installation space.



The advantages of Modul 45 at a glance:

- Space savings thanks to compact design
- Modular structure
- Quick and easy planning
- Simple mounting
- High efficiency due to time and cost savings
- Wide range of application options
- Easy exchangeability





Modul 45® and standard installation solutions for device installation trunking and service poles

	Modul 45®, Pre-terminated installation units for 80 mm duct systems	50
	Modul 45®, device installation in 80 mm duct systems	54
	Standard, device installation in 80 mm duct systems	57



Socket unit AR45, single

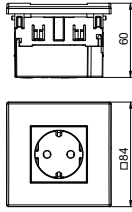

Type	Colour	Pack. pcs	Weight kg/100 pcs.	Item No.
SDE-RW D0RW1	Pure white	4	10.700	6119401
SDE-RW D0GN1	Mint green	4	10.700	6119402
SDE-RW D0RT1	Signal red	4	10.700	6119403

PC Polycarbonate

Pre-terminated socket unit without labelling panel, suitable for installation in Rapid 80 device installation trunking systems. Socket unit, consisting of:

- Service unit, single, type 71GD8-2.
- Protective contact socket, single, 0° connection direction, colour: see table.
- Cover frame AR45, single, without labelling panel, colour: pure white

Socket unit AR45, double

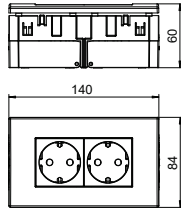

Type	Colour	Pack. pcs	Weight kg/100 pcs.	Item No.
SDE-RW D0RW2	Pure white	2	19.000	6119407
SDE-RW D0GN2	Mint green	2	19.000	6119408
SDE-RW D0RT2	Signal red	2	19.000	6119409

PC Polycarbonate

Pre-terminated socket unit without labelling panel, suitable for installation in Rapid 80 device installation trunking systems. Socket unit, consisting of:

- Service unit, double, type 71GD13
- Protective contact socket, double, 0° connection direction, colour: see table
- Cover frame AR45, double, without labelling panel, type AR45-BF..., colour: pure white

Socket unit AR45, triple

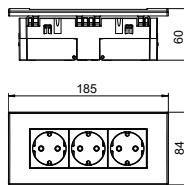

Type	Colour	Pack. pcs	Weight kg/100 pcs.	Item No.
SDE-RW D0RW3	Pure white	2	23.300	6119414
SDE-RW D0GN3	Mint green	2	23.300	6119415
SDE-RW D0RT3	Signal red	2	23.300	6119413

PC Polycarbonate

Pre-terminated socket unit without labelling panel, suitable for installation in Rapid 80 device installation trunking systems. Socket unit, consisting of:

- Service unit, triple, type 71GD9-2
- Protective contact socket, triple, 0° connection direction, colour: see table
- Cover frame AR45, triple, without labelling panel, type AR45-BF..., colour: pure white

Socket unit AR45, single, with labelling panel for horizontal device installation

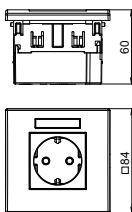

Type	Colour	Pack. pcs	Weight kg/100 pcs.	Item No.
SDE-RW D0RW1B	Pure white	4	10.700	6119421
SDE-RW D0GN1B	Mint green	4	10.700	6119422
SDE-RW D0RT1B	Signal red	4	10.700	6119423

PC Polycarbonate

Pre-terminated socket unit with labelling panel, suitable for installation in Rapid 80 device installation trunking systems. Socket unit, consisting of:

- Service unit, single, type 71GD8-2
- Protective contact socket, single, 0° connection direction, colour: see table
- Cover frame AR45, single, with labelling panel, type AR45-BF..., colour: pure white

Socket unit AR45, double, with labelling panel for horizontal device installation

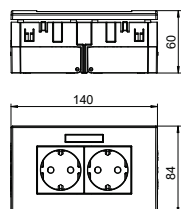

Type	Colour	Pack. pcs	Weight kg/100 pcs.	Item No.
SDE-RW D0RW2B	Pure white	2	19.000	6119427
SDE-RW D0GN2B	Mint green	2	19.000	6119428
SDE-RW D0RT2B	Signal red	2	19.000	6119429

PC Polycarbonate

Pre-terminated socket unit with labelling panel, suitable for installation in Rapid 80 device installation trunking systems. Socket unit, consisting of:

- Service unit, double, type 71GD13
- Protective contact socket, double, 0° connection direction, colour: see table
- Cover frame AR45, double, with labelling panel, type AR45-BF..., colour: pure white

Socket unit AR45, triple, with labelling panel for horizontal device installation

Type	Colour	Pack. pcs	Weight kg/100 pcs.	Item No.
SDE-RW D0RW3B	Pure white	2	23.300	6119433
SDE-RW D0GN3B	Mint green	2	23.300	6119434
SDE-RW D0RT3B	Signal red	2	23.300	6119435

PC Polycarbonate

Pre-terminated socket unit with labelling panel, suitable for installation in Rapid 80 device installation trunking systems. Socket unit, consisting of:

- Service unit, triple, type 71GD9-2
- Protective contact socket, triple, 0° connection direction, colour: see table
- Cover frame AR45, triple, with labelling panel, type AR45-BF..., colour: pure white

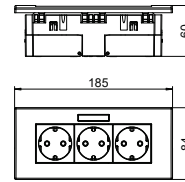

Socket unit CEE, single, 16 A

Type	Colour	Pack. pcs	Weight kg/100 pcs.	Item No.
71GDCEE16	Graphite black	1	31.100	6119483

PA Polyamide

Accessory mounting box for the installation of a 3 or 5-pole CEE socket, 16 A or 32 A.

Scope of delivery:

- 1 front-locking accessory mounting box for 4-point fastening track of 52 x 52 mm to 70 x 70 mm
- 1 cover frame in pure white for hiding the fastening technology
- 2 external strain reliefs for jacketed cables of up to Ø 18 mm
- 2 sash locks for optional fastening to duct bases with C rail
- 1 CEE socket 16 A with mounting accessories

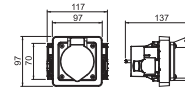

Socket unit CEE, single, 32 A

Type	Colour	Pack. pcs	Weight kg/100 pcs.	Item No.
71GDCEE32	Graphite black	1	37.200	6119485

PA Polyamide

Accessory mounting box for the installation of a 3 or 5-pole CEE socket, 16 A or 32 A.

Scope of delivery:

- 1 front-locking accessory mounting box for 4-point fastening track of 52 x 52 mm to 70 x 70 mm
- 1 cover frame in pure white for hiding the fastening technology
- 2 external strain reliefs for jacketed cables of up to Ø 18 mm
- 2 sash locks for optional fastening to duct bases with C rail
- 1 CEE socket 32 A with mounting accessories

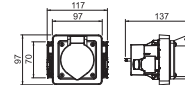

Installation unit AR45, for 2 PU

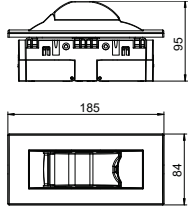

Type	Colour	Pack. pcs	Weight kg/100 pcs.	Item No.
IKR-6 RW	Pure white	1	19.000	6119319
PC Polycarbonate				

Installation unit to accept protective units such as miniature circuit breakers or FI protection switches up to max. 2 PUs, suitable for installation in Rapid 80 device installation trunking systems and ISS service poles.

Installation unit, consisting of:

- Accessory mounting box, triple, type 71GD9-2
- Cover, incl. PVC support clamp for 2 PUs, colour: see table
- Cover frame AR45, triple, without labelling panel, colour: pure white

Installation unit

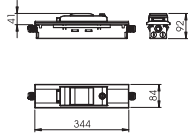

Type	Installation depth mm	Pack. pcs	Weight kg/100 pcs.	Item No.
IKR4RW	52	1	85.400	6288365

Installation unit for the installation of automatic circuit breakers or FI protection switches in device installation trunking. With 1 hat rail of 3 part units. Series terminals for N and PE on hat rails, completely wired with 6 mm². The installation unit is pre-wired and ready for connection. The cable cross-section is 6 mm². Two type V-Tec M20 cable glands for cable entry are included in the delivery.



Flush-mount unit for data technology, type A

Type	Colour	Pack.		Weight	Item No.
		pcs	kg/100 pcs.		
DTE-RW G2A1	Pure white	4	5.000		6119494
PC Polycarbonate					

Flush-mount unit to accept two Type A data technology modules, suitable for installation in Rapid 80 device installation trunking systems and ISS service poles. The type A data technology support is suitable for accepting the following data connection modules: AMP TYCO (without dust protection cap): SL Series 110Connect and SL Series Toolless; Brand-Rex: modules with item numbers ending in ...JAKS000CR and ...JAKU002; Nexans: LANmark RJ45 with blue adapter clip, LANmark GG45 with metal clip.

Flush-mount unit, consisting of:

- Mounting support, single, type 71MT1 45
- Data technology support, straight outlet, type DTG-2A, colour: See table
- Cover frame AR45, single, without labelling panel, colour: Pure white

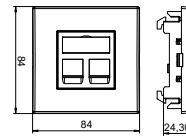

Flush-mount unit for data technology, type C

Type	Colour	Pack.		Weight	Item No.
		pcs	kg/100 pcs.		
DTE-RW G2C1	Pure white	4	5.000		6119492
PC Polycarbonate					

Flush-mount unit to accept two Type C data technology modules, suitable for installation in Rapid 80 device installation trunking systems and ISS service poles. The type C data technology support is suitable for accepting the following data connection modules: BTR (Keystone design): Cat. 6A module and UAE module; Corning: modules with Keystone seat; CobiNet: CobiDat KS module; Dätwyler: KS-T, KS-TS, MS-K and KU-T; EKU: E-Stone; Harting: Prelink Keystone Cat. 6A; Fix-link Keystone Cat. 6A; Komos: KDM 500 module; Leoni Kerpen: MegaLine Keystone Cat. 6A; OBO: Type ASM-C6A and ASM-C6A G; R&M: Cat. 6A with Keystone fastening; Rutenbeck: UM and UMflex; SETEC: UKJ and XKJ; Telegärtner: AMJ and UMJ.

Flush-mount unit, consisting of:

- Mounting support, single, type 71MT1 45
- Data technology support, straight outlet, type DTG-2C, colour: See table
- Cover frame AR45, single, without labelling panel, colour: Pure white

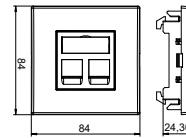

Flush-mount unit for data technology, type RM

Type	Colour	Pack.		Weight	Item No.
		pcs	kg/100 pcs.		
DTE-RW G2RM1	Pure white	4	5.000		6119490
PC Polycarbonate					

Flush-mount unit to accept two Type RM data technology modules, suitable for installation in Rapid 80 device installation trunking systems and ISS service poles. The type RM data technology support is suitable for accepting the following data connection modules: OBO (type): ASM-C5, ASM-C5 G, ASM-C6 and ASM-C6 G; R&M: Cat. 5 and Cat. 6 modules without support plate.

Flush-mount unit, consisting of:

- Mounting support, single, type 71MT1 45
- Data technology support, straight outlet, type DTG-2RM, colour: See table
- Cover frame AR45, single, without labelling panel, colour: Pure white

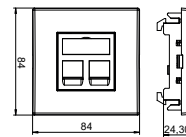

Modul 45®, device installation solution, single

Accessory mounting box, single, Modul 45

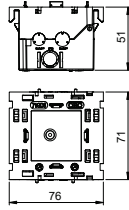

Type	Colour	Pack. pcs	Weight kg/100 pcs.	Item No.

PA Polyamide

Front locking single accessory mounting box for Modul 45 system, with folding, and also removable, base for time saving cable connection, with feed openings for cable diameters of up to 14 mm.

Mounting support, single, for Modul 45

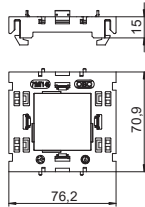

Type	Colour	Pack. pcs	Weight kg/100 pcs.	Item No.

PA Polyamide

Front locking single mounting support for Modul 45 data technology systems and Modul 45connect protective contact sockets with Wieland connection.

Cover frame AR45, single

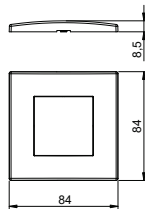

Type	Colour	Pack. pcs	Weight kg/100 pcs.	Item No.
AR45-F1 SWGR	Black-grey	1	1.600	6119324
AR45-F1 AL	Aluminium painted	1	1.600	6119326

PC Polycarbonate

Front locking cover frame for Modul 45 devices, single, without labelling panel for horizontal and vertical device installation, for locking in accessory mounting box 71GD8-2.

Cover frame AR45, single, with labelling panel for horizontal device installation

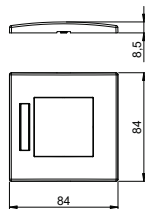

Type	Colour	Pack. pcs	Weight kg/100 pcs.	Item No.
AR45-BF1 SWGR	Black-grey	1	1.500	6119334
AR45-BF1 AL	Aluminium painted	1	1.500	6119336

PC Polycarbonate

Front locking cover frame for Modul 45 devices, single, with labelling panel for horizontal device installation, for locking in accessory mounting box 71GD8-2.

Cover frame AR45, single, with labelling panel for vertical device installation

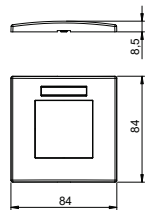

Type	Colour	Pack. pcs	Weight kg/100 pcs.	Item No.
AR45-BSF1 SWGR	Black-grey	1	1.500	6119339
AR45-BSF1 AL	Aluminium painted	1	1.500	6119340

PC Polycarbonate

Front locking cover frame for Modul 45 devices, single, with labelling panel for vertical device installation, for locking in accessory mounting box 71GD8-2.

Accessory mounting box, double, Modul 45

Type	Pack. pcs	Weight		Item No.
		kg/100	pcs.	
71GD13	1	11.000		6288583

PA Polyamide

Front locking double accessory mounting box for Modul 45 system, with folding, and also removable, base for time saving cable connection, with feed openings for cable diameters of up to 14 mm.

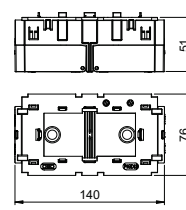

Mounting support, double, for Modul 45

Type	Pack. pcs	Weight		Item No.
		kg/100	pcs.	
71MT2 45	5	3.050		6288576

PA Polyamide

Front locking double mounting support for Modul 45 data technology systems and Modul 45connect protective contact sockets with Wieland connection.

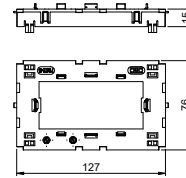

Cover frame AR45, double

Type	Colour		Pack. pcs	Weight		Item No.
				kg/100	pcs.	
AR45-F2 RW	Pure white		1	2.320		6119342
AR45-F2 SWGR	Black-grey		1	2.320		6119344
AR45-F2 AL	Aluminium painted		1	2.320		6119346

PC Polycarbonate

Front locking cover frame for Modul 45 devices, single, without labelling panel for horizontal and vertical device installation, for locking in accessory mounting box 71GD13 or in mounting support 71MT2 45.

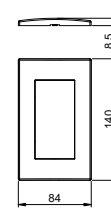

Cover frame AR45, double, with labelling panel for horizontal device installation

Type	Colour		Pack. pcs	Weight		Item No.
				kg/100	pcs.	
AR45-BF2 RW	Pure white		1	2.260		6119352
AR45-BF2 SWGR	Black-grey		1	2.260		6119354
AR45-BF2 AL	Aluminium painted		1	2.260		6119356

PC Polycarbonate

Front locking cover frame for Modul 45 devices, double, with labelling panel for horizontal device installation, for locking in accessory mounting box 71GD13 or in mounting support 71MT2 45.

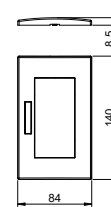

Cover frame AR45, double, with labelling panel for vertical device installation

Type	Colour		Pack. pcs	Weight		Item No.
				kg/100	pcs.	
AR45-BSF2 RW	Pure white		1	2.260		6119362
AR45-BSF2 SWGR	Black-grey		1	2.260		6119364
AR45-BSF2 AL	Aluminium painted		1	2.260		6119366

PC Polycarbonate

Front locking cover frame for Modul 45 devices, double, with labelling panel for vertical device installation, for locking in accessory mounting box 71GD13 or in mounting support 71MT2 45.

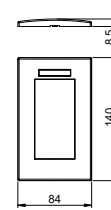

07_EGS_Produnkteilheitenkatalog_EX_2018 / en / 2018/10/08 08:19:15 (LLEExport_02229) / 2018/10/08 08:22:22 08:22:22

Modul 45® and standard installation solutions for device installation ducts and service poles with 80 mm system opening



Modul 45®, device installation solution, triple

Accessory mounting box, triple, Modul 45

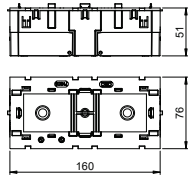

Type	Designation	Pack. Weight		Item No.
		pcs	kg/100 pcs.	
71GD9-2	Accessory mounting box	1	11.600	6288579
PA Polyamide				

Front locking triple accessory mounting box for Modul 45 system, with folding, and also removable, base for time saving cable connection, with feed openings for cable diameters of up to 14 mm.

Mounting support, triple, for Modul 45

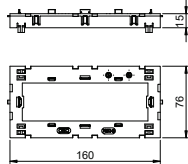

Type	Designation	Pack. Weight		Item No.
		pcs	kg/100 pcs.	
71MT3 45-2		5	3.200	6288574
PA Polyamide				

Front locking double/triple mounting support for Modul 45 data technology systems and Modul 45connect protective contact sockets with Wieland connection.

Cover frame AR45, triple

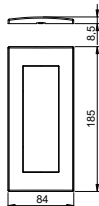

Type	Colour	Pack. Weight		Item No.
		pcs	kg/100 pcs.	
AR45-F3 RW	Pure white	1	2.800	6119372
AR45-F3 SWGR	Black-grey	1	2.800	6119374
AR45-F3 AL	Aluminium painted	1	2.800	6119376
PC Polycarbonate				

Front locking cover frame for Modul 45 devices, triple, without labelling panel for horizontal and vertical device installation, for locking in accessory mounting box 71GD9-2 or in mounting support 71MT3 45-2.

Cover frame AR45, triple, with labelling panel for horizontal device installation

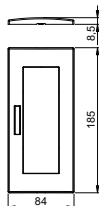

Type	Colour	Pack. Weight		Item No.
		pcs	kg/100 pcs.	
AR45-BF3 RW	Pure white	1	2.800	6119382
AR45-BF3 SWGR	Black-grey	1	2.800	6119384
AR45-BF3 AL	Aluminium painted	1	2.800	6119386
PC Polycarbonate				

Front locking cover frame for Modul 45 devices, triple, with labelling panel for horizontal device installation, for locking in accessory mounting box 71GD9-2 or in mounting support 71MT3 45-2.

Cover frame AR45, triple, with labelling panel for vertical device installation

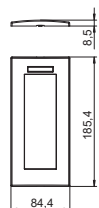

Type	Colour	Pack. Weight		Item No.
		pcs	kg/100 pcs.	
AR45-BSF3 RW	Pure white	1	2.800	6119387
AR45-BSF3 SWGR	Black-grey	1	2.800	6119388
AR45-BSF3 AL	Aluminium painted	1	2.800	6119389
PC Polycarbonate				

Front locking cover frame for Modul 45 devices, triple, with labelling panel for vertical device installation, for locking in accessory mounting box 71GD9-2 or in mounting support 71MT3 45-2.

Accessory mounting box, single



Colour		Pack.	Weight	Item No.
Type		pcs	kg/100 pcs.	
71GD6	Iron grey	5	5.600	6288610

PA Polyamide

Front locking accessory mounting box for switch systems, with folding, and also removable, base for time saving cable connection, with feed openings for cable diameters of up to 14 mm.

Horizontal fixing track 60 mm.

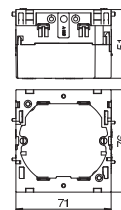

Accessory mounting box, double

Colour		Pack.	Weight	Item No.
Type		pcs	kg/100 pcs.	
71GD7	Iron grey	2	11.000	6288611

PA Polyamide

Front locking accessory mounting box for standard switch ranges for the installation of two individual installation devices or a multiple power socket. With unfolding, and also removable, base for time-saving cable connection and with feed openings for cable diameters of up to 14 mm.

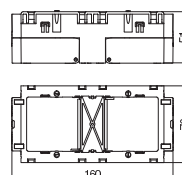

Accessory mounting box with large installation opening



Colour		Pack.	Weight	Item No.
Type		pcs	kg/100 pcs.	
71GD11	Iron grey	1	4.600	6288532

PA Polyamide

Accessory mounting box to accept standard switching and connection devices in support ring and support clamp versions of all manufacturers. An extra large installation opening means that the box is also suited to accept ELKO devices as well as larger versions of data technology connection sockets. With the data technology application, it is possible to do without the protective housing if necessary.

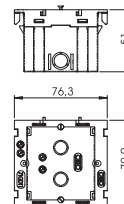

Colour		Pack.	Weight	Item No.
Type		pcs	kg/100 pcs.	
7ZE	Iron grey	50	0.700	6288790

PA Polyamide

Strain relief with locking clips, suitable for the accessory mounting boxes 7GD... and 71GD... .

Cable clamping range to 14 mm.

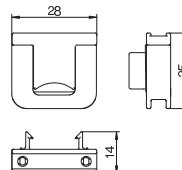

Mounting support for data technology

Colour		Pack.	Weight	Item No.
Type		pcs	kg/100 pcs.	
71MTD	Iron grey	5	1.640	6288577

PA Polyamide

Mounting support for the installation of data technology devices in device installation trunking of the Rapid 80 series and ISS service poles with 80 mm system opening.

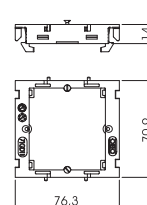

Cover frame AR50, single

Colour		Pack.	Weight	Item No.
Type		pcs	kg/100 pcs.	
AR50-F1 RW	Pure white	1	1.620	6119392
AR50-F1 SWGR	Black-grey	1	1.620	6119394
AR50-F1 AL	Aluminium painted	1	1.620	6119396

PC Polycarbonate

Front locking cover frame for devices with 50 mm central plate, single, without labelling panel for horizontal and vertical device installation, for mounting on accessory mounting box 71GD6, 71GD11 or in mounting support 71MTD.

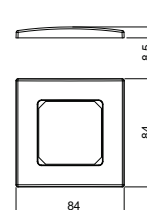

CEE installation

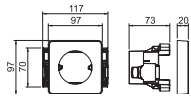

Type	Colour	Pack. Weight		Item No.
		pcs	kg/100 pcs.	
71GDCEE	—	1	13.700	6288635

PA Polyamide

Accessory mounting box for installation of a 5-pole CEE socket, 16 A or 32 A. With four-point fastening track 60 x 60 mm or 70 x 70 mm; with external strain relief for jacketed cables of up to Ø 18 mm; with eccentric lock for quick, screwless fastening.

Socket unit CEE, single, 16 A

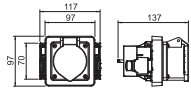

Type	Colour	Pack. Weight		Item No.
		pcs	kg/100 pcs.	
71GDCEE16	Graphite black	1	31.100	6119483

PA Polyamide

Accessory mounting box for the installation of a 3 or 5-pole CEE socket, 16 A or 32 A.

Scope of delivery:

- 1 front-locking accessory mounting box for 4-point fastening track of 52 x 52 mm to 70 x 70 mm
- 1 cover frame in pure white for hiding the fastening technology
- 2 external strain reliefs for jacketed cables of up to Ø 18 mm
- 2 sash locks for optional fastening to duct bases with C rail
- 1 CEE socket 16 A with mounting accessories

Socket unit CEE, single, 32 A

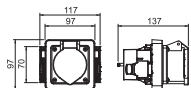

Type	Colour	Pack. Weight		Item No.
		pcs	kg/100 pcs.	
71GDCEE32	Graphite black	1	37.200	6119485

PA Polyamide

Accessory mounting box for the installation of a 3 or 5-pole CEE socket, 16 A or 32 A.

Scope of delivery:

- 1 front-locking accessory mounting box for 4-point fastening track of 52 x 52 mm to 70 x 70 mm
- 1 cover frame in pure white for hiding the fastening technology
- 2 external strain reliefs for jacketed cables of up to Ø 18 mm
- 2 sash locks for optional fastening to duct bases with C rail
- 1 CEE socket 32 A with mounting accessories



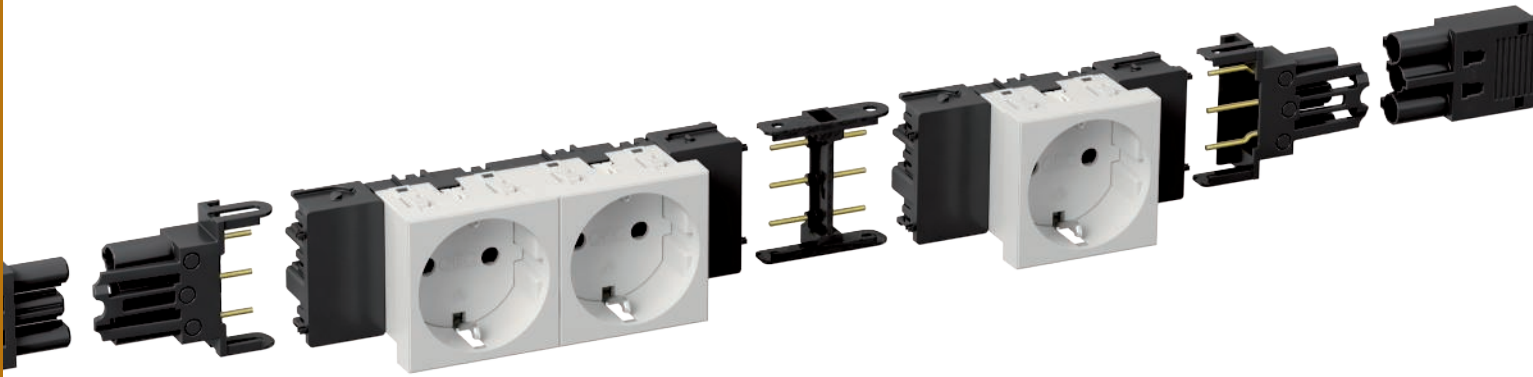







Modul 45connect® plug-in installation solutions for device installation trunking and service poles

As continuously connectable installation technology, Modul 45connect for device installation trunking and service poles offers the highest level of flexibility, security and cost efficiency.

From energy distribution through to device connection in the trunking, the system offers all the required installation components.



Modul 45connect® – plug-in installation solutions for device installation ducts and service poles

	Modul 45connect®, sockets for Rapid 45 device installation ducts	62
	Modul 45connect®, sockets for Rapid 80 device installation ducts	64
	Modul 45connect®, 33° sockets for ISS service poles	66
	Modul 45connect®, connection adapter for sockets	68
	Modul 45connect®, cover frame for 80 mm duct systems	69
	Consolidation Point	71
	Installation accessories for plug connector systems	74

Socket 0°, Connect 45, protective contact, single

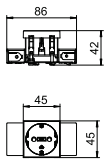

Type	STD-D0C RW1	STD-D0C ROR1	STD-D0C MZGN1	STD-D0C SRO1	STD-D0C SWGR1	STD-D0C AL1
Colour	Pure white	Pure orange	Mint green	Signal red	Black-grey	Aluminium painted
Pack. pcs	1	1	1	1	1	1
Weight kg/100 pcs.	6.700	6.700	6.700	6.700	6.700	6.700
Item No.	6120340	6120344	6120346	6120348	6120350	6120352

PC Polycarbonate

Protective contact socket with connection to side, single 0°, with increased touch protection, with screwless terminals, 2-pin, 16 A, 250 V~, with connection terminals to IEC 60884-1, suitable for the installation in Rapid 45 device installation trunking system.

Socket 0°, Connect 45, protective contact, double

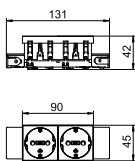

Type	STD-D0C RW2	STD-D0C ROR2	STD-D0C MZGN2	STD-D0C SRO2	STD-D0C SWGR2	STD-D0C AL2
Colour	Pure white	Pure orange	Mint green	Signal red	Black-grey	Aluminium painted
Pack. pcs	1	1	1	1	1	1
Weight kg/100 pcs.	10.100	10.100	10.100	10.100	10.100	10.100
Item No.	6120362	6120364	6120366	6120368	6120370	6120372

PC Polycarbonate

Protective contact socket with connection to side, double 0°, with increased touch protection, with screwless terminals, 2-pin, 16 A, 250 V~, with connection terminals to IEC 60884-1, suitable for the installation in Rapid 45 device installation trunking systems.

Socket 0°, Connect 45, protective contact, triple

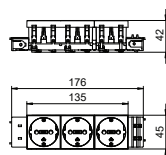

Type	STD-D0C RW3	STD-D0C ROR3	STD-D0C MZGN3	STD-D0C SRO3	STD-D0C SWGR3	STD-D0C AL3
Colour	Pure white	Pure orange	Mint green	Signal red	Black-grey	Aluminium painted
Pack. pcs	1	1	1	1	1	1
Weight kg/100 pcs.	16.500	16.500	16.500	16.500	16.500	16.500
Item No.	6120382	6120384	6120386	6120388	6120390	6120392

PC Polycarbonate

Protective contact socket with connection to side, triple 0°, with increased touch protection, with screwless terminals, 2-pin, 16 A, 250 V~, with connection terminals to IEC 60884-1, suitable for the installation in Rapid 45 device installation trunking systems.

Socket 0°, Connect 45, with earthing pin, single

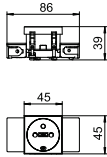

Type	STD-F0C RW1	STD-F0C ROR1	STD-F0C MZGN1	STD-F0C SRO1	STD-F0C SWGR1	STD-F0C AL1
Colour	Pure white	Pure orange	Mint green	Signal red	Black-grey	Aluminium painted
Pack. pcs	1	1	1	1	1	1
Weight kg/100 pcs.	6.500	6.500	6.500	6.500	6.500	6.500
Item No.	6120532	6120534	6120536	6120538	6120540	6120542

PC Polycarbonate

Earthing pin socket with connection to side, single 0°, with increased touch protection, with screwless terminals, 2-pin, 16 A, 250 V~, with connection terminals to IEC 60884-1, suitable for the installation in Rapid 45 device installation trunking systems.

Socket 0°, Connect 45, with earthing pin, double

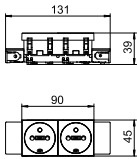

Type	STD-F0C RW2	STD-F0C ROR2	STD-F0C MZGN2	STD-F0C SRO2	STD-F0C SWGR2	STD-F0C AL2
Colour	Pure white	Pure orange	Mint green	Signal red	Black-grey	Aluminium painted
Pack. pcs	1	1	1	1	1	1
Weight kg/100 pcs.	9.900	9.900	9.900	9.900	9.900	9.900
Item No.	6120552	6120554	6120556	6120558	6120560	6120562

PC Polycarbonate

Earthing pin socket with connection to side, double 0°, with increased touch protection, with screwless terminals, 2-pin, 16 A, 250 V~, with connection terminals to IEC 60884-1, suitable for the installation in Rapid 45 device installation trunking systems.

Socket 0°, Connect 45, with earthing pin, triple

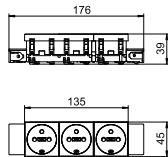

Type	STD-F0C RW3	STD-F0C ROR3	STD-F0C MZGN3	STD-F0C SRO3	STD-F0C SWGR3	STD-F0C AL3
Colour	Pure white	Pure orange	Mint green	Signal red	Black-grey	Aluminium painted
Pack. pcs	1	1	1	1	1	1
Weight kg/100 pcs.	13.900	13.900	13.900	13.900	13.900	13.900
Item No.	6120572	6120574	6120576	6120578	6120580	6120582

PC Polycarbonate

Earthing pin socket with connection to side, triple 0°, with increased touch protection, with screwless terminals, 2-pin, 16 A, 250 V~, with connection terminals to IEC 60884-1, suitable for the installation in Rapid 45 device installation trunking systems.



Socket 0°, Connect 80, protective contact, single

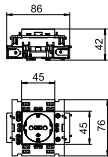

Type	STD-D0C8 RW1	STD-D0C8 ROR1	STD-D0C8 MZGN1	STD-D0C8 SRO1	STD-D0C8 SWGR1	STD-D0C8 AL1
Colour	Pure white	Pure orange	Mint green	Signal red	Black-grey	Aluminium painted
Pack. pcs	1	1	1	1	1	1
Weight kg/100 pcs.	8.500	8.500	8.500	8.500	8.500	8.500
Item No.	6120412	6120414	6120416	6120418	6120420	6120422

PC Polycarbonate

Protective contact socket with connection to side, single 0°, with increased touch protection, with screwless terminals, 2-pin, 16 A, 250 V~, with connection terminals to IEC 60884-1, suitable for the installation in Rapid 80 device installation trunking system.

Socket 0°, Connect 80, protective contact, double

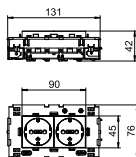

Type	STD-D0C8 RW2	STD-D0C8 ROR2	STD-D0C8 MZGN2	STD-D0C8 SRO2	STD-D0C8 SWGR2	STD-D0C8 AL2
Colour	Pure white	Pure orange	Mint green	Signal red	Black-grey	Aluminium painted
Pack. pcs	1	1	1	1	1	1
Weight kg/100 pcs.	13.000	13.000	13.000	13.000	13.000	13.000
Item No.	6120432	6120434	6120436	6120438	6120440	6120442

PC Polycarbonate

Protective contact socket with connection to side, double 0°, with increased touch protection, with screwless terminals, 2-pin, 16 A, 250 V~, with connection terminals to IEC 60884-1, suitable for the installation in Rapid 80 device installation trunking systems.

Socket 0°, Connect 80, protective contact, triple

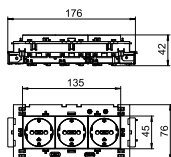

Type	STD-D0C8 RW3	STD-D0C8 ROR3	STD-D0C8 MZGN3	STD-D0C8 SRO3	STD-D0C8 SWGR3	STD-D0C8 AL3
Colour	Pure white	Pure orange	Mint green	Signal red	Black-grey	Aluminium painted
Pack. pcs	1	1	1	1	1	1
Weight kg/100 pcs.	20.000	20.000	20.000	20.000	20.000	20.000
Item No.	6120452	6120454	6120456	6120458	6120460	6120462

PC Polycarbonate

Protective contact socket with connection to side, triple 0°, with increased touch protection, with screwless terminals, 2-pin, 16 A, 250 V~, with connection terminals to IEC 60884-1, suitable for the installation in Rapid 80 device installation trunking systems.

Socket 0°, Connect 80, with earthing pin, single

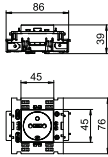

Type	STD-F0C8 RW1	STD-F0C8 ROR1	STD-F0C8 MZGN1	STD-F0C8 SRO1	STD-F0C8 SWGR1	STD-F0C8 AL1
Colour	Pure white	Pure orange	Mint green	Signal red	Black-grey	Aluminium painted
Pack. pcs	1	1	1	1	1	1
Weight kg/100 pcs.	8.500	8.500	8.500	8.500	8.500	8.500
Item No.	6120602	6120604	6120606	6120608	6120610	6120612

PC Polycarbonate

Earthing pin socket with connection to side, single 0°, with increased touch protection, with screwless terminals, 2-pin, 16 A, 250 V~, with connection terminals to IEC 60884-1, suitable for the installation in Rapid 80 device installation trunking systems.

Socket 0°, Connect 80, with earthing pin, double

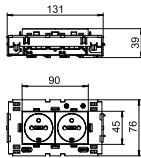

Type	STD-F0C8 RW2	STD-F0C8 ROR2	STD-F0C8 MZGN2	STD-F0C8 SRO2	STD-F0C8 SWGR2	STD-F0C8 AL2
Colour	Pure white	Pure orange	Mint green	Signal red	Black-grey	Aluminium painted
Pack. pcs	1	1	1	1	1	1
Weight kg/100 pcs.	13.000	13.000	13.000	13.000	13.000	13.000
Item No.	6120622	6120624	6120626	6120628	6120630	6120632

PC Polycarbonate

Earthing pin socket with connection to side, double 0°, with increased touch protection, with screwless terminals, 2-pin, 16 A, 250 V~, with connection terminals to IEC 60884-1, suitable for the installation in Rapid 80 device installation trunking systems.

Socket 0°, Connect 80, with earthing pin, triple

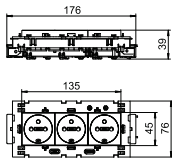

Type	STD-F0C8 RW3	STD-F0C8 ROR3	STD-F0C8 MZGN3	STD-F0C8 SRO3	STD-F0C8 SWGR3	STD-F0C8 AL3
Colour	Pure white	Pure orange	Mint green	Signal red	Black-grey	Aluminium painted
Pack. pcs	1	1	1	1	1	1
Weight kg/100 pcs.	17.500	17.500	17.500	17.500	17.500	17.500
Item No.	6120642	6120644	6120646	6120648	6120650	6120652

PC Polycarbonate

Earthing pin socket with connection to side, triple 0°, with increased touch protection, with screwless terminals, 2-pin, 16 A, 250 V~, with connection terminals to IEC 60884-1, suitable for the installation in Rapid 80 device installation trunking systems.



07_EGS_Produnkteilheitenkatalog_EX_2018 / en / 2018/10/08 08:19:15 08:19:15 (LLEExport_022229) / 2018/10/08 08:22:22 08:22:22

Modul 45connect® protective contact sockets 33°

Socket 33°, Connect 45, protective contact, double

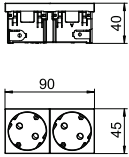

Type	STD-D3C RW2	STD-D3C ROR2	STD-D3C MZGN2	STD-D3C SRO2	STD-D3C SWGR2	STD-D3C AL2
Colour	Pure white	Pure orange	Mint green	Signal red	Black-grey	Aluminium painted
Pack. pcs	1	1	1	1	1	1
Weight kg/100 pcs.	8.500	8.500	8.500	8.500	8.500	8.500
Item No.	6120482	6120484	6120486	6120488	6120490	6120492

PC Polycarbonate

Power socket with side connection double 33°, with increased touch protection with screwless terminals, 2-pin, 16 A, 250 V~, with connection terminals to IEC 60884-1.

Socket 33°, Connect 45, protective contact, triple

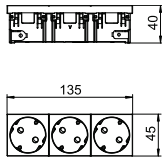

Type	STD-D3C RW3	STD-D3C ROR3	STD-D3C MZGN3	STD-D3C SRO3	STD-D3C SWGR3	STD-D3C AL3
Colour	Pure white	Pure orange	Mint green	Signal red	Black-grey	Aluminium painted
Pack. pcs	1	1	1	1	1	1
Weight kg/100 pcs.	11.500	11.500	11.500	11.500	11.500	11.500
Item No.	6120502	6120504	6120506	6120508	6120510	6120512

PC Polycarbonate

Power socket with side connection triple 33°, with increased touch protection with screwless terminals, 2-pin, 16 A, 250 V~, with connection terminals to IEC 60884-1.

Mounting support, double, for Modul 45

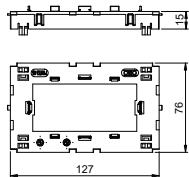

Type	Pack. pcs	Weight kg/100 pcs.	Item No.
71MT2 45	5	3.050	6288576

PA Polyamide

Front locking double mounting support for Modul 45 data technology systems and Modul 45connect protective contact sockets with Wieland connection.

Mounting support, triple, for Modul 45

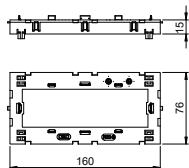

Type	Pack. pcs	Weight kg/100 pcs.	Item No.
71MT3 45-2	5	3.200	6288574

PA Polyamide

Front locking double/triple mounting support for Modul 45 data technology systems and Modul 45connect protective contact sockets with Wieland connection.

Socket 33°, Connect 45, with earthing pin, double

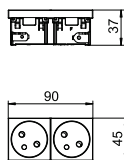

Type	STD-F3C RW2	STD-F3C ROR2	STD-F3C MZGN2	STD-F3C SRO2	STD-F3C SWGR2	STD-F3C AL2
Colour	Pure white	Pure orange	Mint green	Signal red	Black-grey	Aluminium painted
Pack. pcs	1	1	1	1	1	1
Weight kg/100 pcs.	8.500	8.500	8.500	8.500	8.500	8.500
Item No.	6120672	6120674	6120676	6120678	6120680	6120682

PC Polycarbonate

Socket with earthing pin and side connection, double 33°, with increased touch protection, with screwless terminals, 2-pin, 16 A, 250 V~, with connection terminals to IEC 60884-1.

Socket 33°, Connect 45, with earthing pin, triple

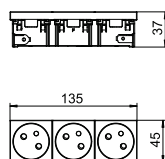

Type	STD-F3C RW3	STD-F3C ROR3	STD-F3C MZGN3	STD-F3C SRO3	STD-F3C SWGR3	STD-F3C AL3
Colour	Pure white	Pure orange	Mint green	Signal red	Black-grey	Aluminium painted
Pack. pcs	1	1	1	1	1	1
Weight kg/100 pcs.	11.500	11.500	11.500	11.500	11.500	11.500
Item No.	6120692	6120694	6120696	6120698	6120700	6120702

PC Polycarbonate

Socket with earthing pin and side connection, triple 33°, with increased touch protection, with screwless terminals, 2-pin, 16 A, 250 V~, with connection terminals to IEC 60884-1.

Mounting support, double, for Modul 45

Type	Pack. pcs	Weight kg/100 pcs.	Item No.
71MT2 45	5	3.050	6288576

PA Polyamide

Front locking double mounting support for Modul 45 data technology systems and Modul 45connect protective contact sockets with Wieland connection.

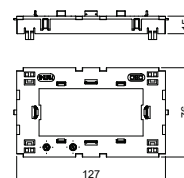

Mounting support, triple, for Modul 45

Type	Pack. pcs	Weight kg/100 pcs.	Item No.
71MT3 45-2	5	3.200	6288574

PA Polyamide

Front locking double/triple mounting support for Modul 45 data technology systems and Modul 45connect protective contact sockets with Wieland connection.

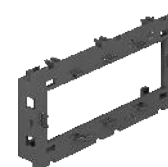
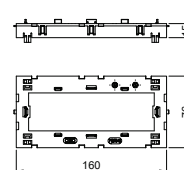

Connection adapter, straight, connector part GST18

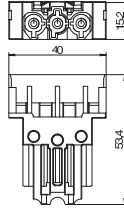

Type	Colour	Pack.	Weight	Item No.
		pcs	kg/100 pcs.	
STA-SKS S1 SW	Black	10	1.200	6117192
STA-SKS S1 W	White	10	1.200	6117193

PA Polyamide

Connector part adapter, straight, for connection to an STD-D0C / STD-D3C or STD-F0C / STD-F3C socket from the side, for VL extension cable with Wieland connector GST 18i 3p.

Connection adapter, straight, socket part GST18

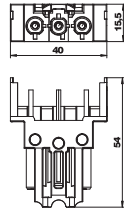

Type	Colour	Pack.	Weight	Item No.
		pcs	kg/100 pcs.	
BTA-SKS S1 SW	Black	10	1.200	6117190
BTA-SKS S1 W	White	10	1.200	6117191

PA Polyamide

Connector part adapter, straight, for connection to an STD-D0C / STD-D3C or STD-F0C / STD-F3C socket from the side, for VL extension cable with Wieland connector GST 18i 3p.

Connection adapter for Modul 45connect® sockets

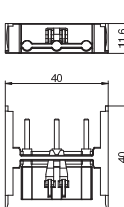

Type	Colour	Pack.	Weight	Item No.
		pcs	kg/100 pcs.	
VB-SKS S	Black	10	0.590	6117198

PA Polyamide

Connection adapter for combining STD-D0C / STD-D3C or STD-F0C / STD-F3C sockets.

Connection adapter, GST18i, straight

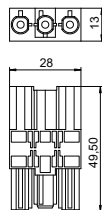

Type	Colour	Pack.	Weight	Item No.
		pcs	kg/100 pcs.	
VB-G GST18i3p	Black	10	1.760	6108045

PA Polyamide

Connection adapter GST18i for combining STD-D0C / STD-D3C or STD-F0C / STD-F3C sockets together with straight connection adapters, pluggable connection with integrated strain relief. Suitable for device connections in the device installation trunking systems Rapid 45 and Rapid 80 and in ISS service poles.



Cover frame AR45, single

Type	Colour	Pack. pcs	Weight kg/100 pcs.	Item No.
AR45-F1 RW	Pure white	1	1.600	6119322
AR45-F1 SWGR	Black-grey	1	1.600	6119324
AR45-F1 AL	Aluminium painted	1	1.600	6119326

PC Polycarbonate

Front locking cover frame for Modul 45 devices, single, without labelling panel for horizontal and vertical device installation, for locking in accessory mounting box 71GD8-2.

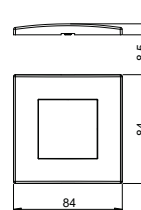

Cover frame AR45, single, with labelling panel for horizontal device installation

Type	Colour	Pack. pcs	Weight kg/100 pcs.	Item No.
AR45-BF1 RW	Pure white	1	1.500	6119332
AR45-BF1 SWGR	Black-grey	1	1.500	6119334
AR45-BF1 AL	Aluminium painted	1	1.500	6119336

PC Polycarbonate

Front locking cover frame for Modul 45 devices, single, with labelling panel for horizontal device installation, for locking in accessory mounting box 71GD8-2.

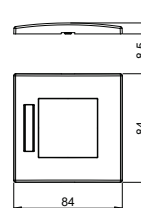

Cover frame AR45, single, with labelling panel for vertical device installation

Type	Colour	Pack. pcs	Weight kg/100 pcs.	Item No.
AR45-BSF1 RW	Pure white	1	1.500	6119338
AR45-BSF1 SWGR	Black-grey	1	1.500	6119339
AR45-BSF1 AL	Aluminium painted	1	1.500	6119340

PC Polycarbonate

Front locking cover frame for Modul 45 devices, single, with labelling panel for vertical device installation, for locking in accessory mounting box 71GD8-2.

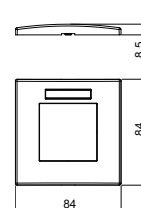

Cover frame AR45, double

Type	Colour	Pack. pcs	Weight kg/100 pcs.	Item No.
AR45-F2 RW	Pure white	1	2.320	6119342
AR45-F2 SWGR	Black-grey	1	2.320	6119344
AR45-F2 AL	Aluminium painted	1	2.320	6119346

PC Polycarbonate

Front locking cover frame for Modul 45 devices, single, without labelling panel for horizontal and vertical device installation, for locking in accessory mounting box 71GD13 or in mounting support 71MT2 45.

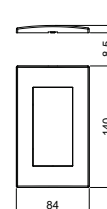

Cover frame AR45, double, with labelling panel for horizontal device installation

Type	Colour	Pack. pcs	Weight kg/100 pcs.	Item No.
AR45-BF2 RW	Pure white	1	2.260	6119352
AR45-BF2 SWGR	Black-grey	1	2.260	6119354
AR45-BF2 AL	Aluminium painted	1	2.260	6119356

PC Polycarbonate

Front locking cover frame for Modul 45 devices, double, with labelling panel for horizontal device installation, for locking in accessory mounting box 71GD13 or in mounting support 71MT2 45.

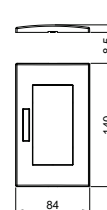

Cover frame AR45, double, with labelling panel for vertical device installation

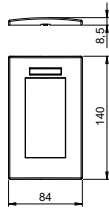

Type	Colour	Pack. pcs	Weight kg/100 pcs.	Item No.
AR45-BSF2 RW	Pure white	1	2.260	6119362
AR45-BSF2 SWGR	Black-grey	1	2.260	6119364
AR45-BSF2 AL	Aluminium painted	1	2.260	6119366

PC Polycarbonate

Front locking cover frame for Modul 45 devices, double, with labelling panel for vertical device installation, for locking in accessory mounting box 71GD13 or in mounting support 71MT2 45.

Cover frame AR45, triple

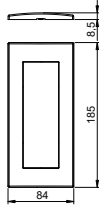

Type	Colour	Pack. pcs	Weight kg/100 pcs.	Item No.
AR45-F3 RW	Pure white	1	2.800	6119372
AR45-F3 SWGR	Black-grey	1	2.800	6119374
AR45-F3 AL	Aluminium painted	1	2.800	6119376

PC Polycarbonate

Front locking cover frame for Modul 45 devices, triple, without labelling panel for horizontal and vertical device installation, for locking in accessory mounting box 71GD9-2 or in mounting support 71MT3 45-2.

Cover frame AR45, triple, with labelling panel for horizontal device installation

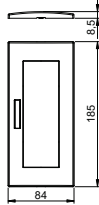

Type	Colour	Pack. pcs	Weight kg/100 pcs.	Item No.
AR45-BF3 RW	Pure white	1	2.800	6119382
AR45-BF3 SWGR	Black-grey	1	2.800	6119384
AR45-BF3 AL	Aluminium painted	1	2.800	6119386

PC Polycarbonate

Front locking cover frame for Modul 45 devices, triple, with labelling panel for horizontal device installation, for locking in accessory mounting box 71GD9-2 or in mounting support 71MT3 45-2.

Cover frame AR45, triple, with labelling panel for vertical device installation

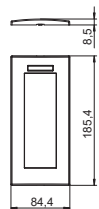

Type	Colour	Pack. pcs	Weight kg/100 pcs.	Item No.
AR45-BSF3 RW	Pure white	1	2.800	6119387
AR45-BSF3 SWGR	Black-grey	1	2.800	6119388
AR45-BSF3 AL	Aluminium painted	1	2.800	6119389

PC Polycarbonate

Front locking cover frame for Modul 45 devices, triple, with labelling panel for vertical device installation, for locking in accessory mounting box 71GD9-2 or in mounting support 71MT3 45-2.



CP empty housing

Type	Pack. pcs	Weight kg/100 pcs.	Item No.

St Steel

Consolidation Point empty housing for the installation of 4 Modul 45 accessories (expandable to max. eight Modul 45 accessories), consisting of housing base and cover, a cover hood to separate data technology and heavy current, two support plates for the installation of two Modul 45 accessories each, two blanking plates, two cable glands V-TEC M25 and a protective conductor connection bracket.

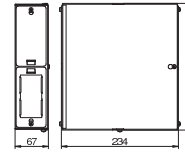

CP support plate, for Modul 45® devices, double

Type	Pack. pcs	Weight kg/100 pcs.	Item No.

St Steel

Support plate to accept two Modul 45 devices in a Consolidation Point housing.

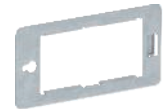
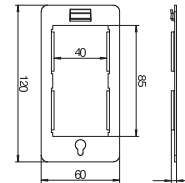

CP support plate for 3 snap-in plug connectors, 3-pole

Type	Pack. pcs	Weight kg/100 pcs.	Item No.

St Steel

Support plate to accept three snap-In connectors, 3-pole, in a Consolidation Point housing.

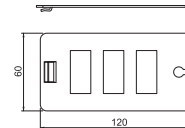

CP support plate for 4 snap-in plug connectors, 3-pole

Type	Pack. pcs	Weight kg/100 pcs.	Item No.

St Steel

Support plate to accept four snap-In connectors, 3-pole, in a Consolidation Point housing.

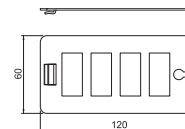

CP support plate, for 8 data connection modules, type C

Type	Pack. pcs	Weight kg/100 pcs.	Item No.

St Steel

Support plate, type C, to accept eight data connection modules in a Consolidation Point housing. Type C has a mounting opening of 19.30 x 14.80 mm.

Support plate type C is suitable for accepting the following data connection modules: BTR (Keystone design): Cat.6A Modul und UAE Modul; Corning: Modules with Keystone seat; CobiNet: CobiDat KS module; Dätwyler: KS-T, KS-TS, MS-K and KU-T; EKU: E-Stone; Harting: Prelink Keystone Cat.6A, Fixlink Keystone Cat.6A; Komos: KDM 500 module; Leoni Kerpen: MegaLine-Connect45 socket modules Keystone; OBO: Data connection modules snap-In type ASM-C5 S, ASM-C5 GS, ASM-C6 S, ASM-C6 GS and Keystone type ASM-C6A, ASM-C6A G; R&M: Cat.6A with Keystone fastening; Rutenbeck: UM and UMflex; SETEC: UKJ and XKJ; Telegärtner: AMJ and UMJ.

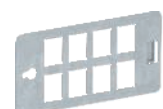
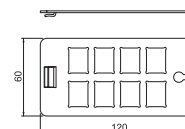

Terminal strip

Type	Pack. pcs	Weight kg/100 pcs.	Item No.

Screwless terminal strip with locking foot, 5-pin for a cable cross-section of 0.5–4 mm².

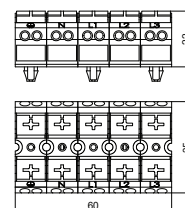

Connection cables with GST18 connector system

3-wire connection cable, PVC, cross-section 1.5 mm², black

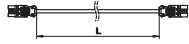

Type	Cable length mm	Cross-section mm ²	Number of poles	Colour	Pack. pcs	Weight kg/100 pcs.	Item No.
VL-3Q1.5 1 SW	1000	1.5	3	Black	1	14.000	6108100
VL-3Q1.5 2 SW	2000	1.5	3	Black	1	28.000	6108101
VL-3Q1.5 3 SW	3000	1.5	3	Black	1	42.000	6108102
VL-3Q1.5 4 SW	4000	1.5	3	Black	1	56.000	6108103
VL-3Q1.5 5 SW	5000	1.5	3	Black	1	70.000	6108104
VL-3Q1.5 6 SW	6000	1.5	3	Black	1	84.000	6108105
VL-3Q1.5 7 SW	7000	1.5	3	Black	1	98.000	6108106
VL-3Q1.5 8 SW	8000	1.5	3	Black	1	112.000	6108107
VL-3Q1.5 9 SW	9000	1.5	3	Black	1	126.000	6108108
VL-3Q1.5 10 SW	10000	1.5	3	Black	1	140.000	6108109

Connection cable 3 x 1.5 mm² in the version socket – connector with GST18i connection system.

3-wire connection cable, PVC, cross-section 1.5 mm², white

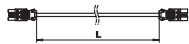

Type	Cable length mm	Cross-section mm ²	Number of poles	Colour	Pack. pcs	Weight kg/100 pcs.	Item No.
VL-3Q1.5 1 W	1000	1.5	3	White	1	14.000	6108125
VL-3Q1.5 2 W	2000	1.5	3	White	1	28.000	6108126
VL-3Q1.5 3 W	3000	1.5	3	White	1	42.000	6108127
VL-3Q1.5 4 W	4000	1.5	3	White	1	56.000	6108128
VL-3Q1.5 5 W	5000	1.5	3	White	1	70.000	6108129
VL-3Q1.5 6 W	6000	1.5	3	White	1	84.000	6108130
VL-3Q1.5 7 W	7000	1.5	3	White	1	98.000	6108131
VL-3Q1.5 8 W	8000	1.5	3	White	1	112.000	6108132
VL-3Q1.5 9 W	9000	1.5	3	White	1	126.000	6108133
VL-3Q1.5 10 W	10000	1.5	3	White	1	140.000	6108134

Connection cable 3 x 1.5 mm² in the version socket – connector with GST18i connection system.

3-wire connection cable, PVC, cross-section 2.5 mm², black



Type	Cable length mm	Cross-section mm ²	Number of poles	Colour	Pack. pcs	Weight kg/100 pcs.	Item No.
VL-3Q2.5 1 SW	1000	2.5	3	Black	1	18.000	6108150
VL-3Q2.5 2 SW	2000	2.5	3	Black	1	36.000	6108151
VL-3Q2.5 3 SW	3000	2.5	3	Black	1	54.000	6108152
VL-3Q2.5 4 SW	4000	2.5	3	Black	1	72.000	6108153
VL-3Q2.5 5 SW	5000	2.5	3	Black	1	90.000	6108154
VL-3Q2.5 6 SW	6000	2.5	3	Black	1	108.000	6108155
VL-3Q2.5 7 SW	7000	2.5	3	Black	1	126.000	6108156
VL-3Q2.5 8 SW	8000	2.5	3	Black	1	144.000	6108157
VL-3Q2.5 9 SW	9000	2.5	3	Black	1	162.000	6108158
VL-3Q2.5 10 SW	10000	2.5	3	Black	1	180.000	6108159

Connection cable 3 x 2.5 mm² in the version socket – connector with GST18i connection system.

3-wire connection cable, PVC, cross-section 2.5 mm², white

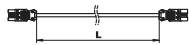

Type	Cable length mm	Cross-section mm ²	Number of poles	Colour	Pack. pcs	Weight kg/100 pcs.	Item No.
VL-3Q2.5 1 W	1000	2.5	3	White	1	18.000	6108175
VL-3Q2.5 2 W	2000	2.5	3	White	1	36.000	6108176
VL-3Q2.5 3 W	3000	2.5	3	White	1	54.000	6108177
VL-3Q2.5 4 W	4000	2.5	3	White	1	72.000	6108178
VL-3Q2.5 5 W	5000	2.5	3	White	1	90.000	6108179
VL-3Q2.5 6 W	6000	2.5	3	White	1	108.000	6108180
VL-3Q2.5 7 W	7000	2.5	3	White	1	126.000	6108181
VL-3Q2.5 8 W	8000	2.5	3	White	1	144.000	6108182
VL-3Q2.5 9 W	9000	2.5	3	White	1	162.000	6108183
VL-3Q2.5 10 W	10000	2.5	3	White	1	180.000	6108184

Connection cable 3 x 2.5 mm² in the version socket – connector with GST18i connection system.



3-wire connection cable, halogen-free, cross-section 2.5 mm², black

Type	Cable length mm	Cross-section mm ²	Number of poles	Colour	Pack. pcs	Weight kg/100 pcs.	Item No.
VL-3Q2.5 H1 SW	1000	2.5	3	Black	1	16.000	6108450
VL-3Q2.5 H2 SW	2000	2.5	3	Black	1	32.000	6108451
VL-3Q2.5 H3 SW	3000	2.5	3	Black	1	48.000	6108452
VL-3Q2.5 H4 SW	4000	2.5	3	Black	1	64.000	6108453
VL-3Q2.5 H5 SW	5000	2.5	3	Black	1	80.000	6108454
VL-3Q2.5 H6 SW	6000	2.5	3	Black	1	96.000	6108455
VL-3Q2.5 H7 SW	7000	2.5	3	Black	1	112.000	6108456
VL-3Q2.5 H8 SW	8000	2.5	3	Black	1	128.000	6108457
VL-3Q2.5 H9 SW	9000	2.5	3	Black	1	144.000	6108458
VL-3Q2.5 H10 SW	10000	2.5	3	Black	1	160.000	6108459

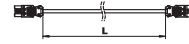

Halogen-free connection cables 3 x 2.5 mm² in the version socket – connector with GST18i connection system.

3-wire connection cable, halogen-free, cross-section 2.5 mm², white

Type	Cable length mm	Cross-section mm ²	Number of poles	Colour	Pack. pcs	Weight kg/100 pcs.	Item No.
VL-3Q2.5 H1 W	1000	2.5	3	White	1	16.000	6108475
VL-3Q2.5 H2 W	2000	2.5	3	White	1	32.000	6108476
VL-3Q2.5 H3 W	3000	2.5	3	White	1	48.000	6108477
VL-3Q2.5 H4 W	4000	2.5	3	White	1	64.000	6108478
VL-3Q2.5 H5 W	5000	2.5	3	White	1	80.000	6108479
VL-3Q2.5 H6 W	6000	2.5	3	White	1	96.000	6108480
VL-3Q2.5 H7 W	7000	2.5	3	White	1	112.000	6108481
VL-3Q2.5 H8 W	8000	2.5	3	White	1	128.000	6108482
VL-3Q2.5 H9 W	9000	2.5	3	White	1	144.000	6108483
VL-3Q2.5 H10 W	10000	2.5	3	White	1	160.000	6108484



Halogen-free connection cables 3 x 2.5 mm² in the version socket – connector with GST18i connection system.



Connector part 3-pin, spring power connection

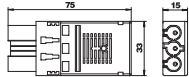

Type	Colour	Pack.	Weight	Item No.
		pcs	kg/100 pcs.	
ST-F GST18i3p SW	Black	1	2.600	6108050
ST-F GST18i3p W	White	1	2.620	6108051

Connector part, 3-pin, type GST18i with spring power connection for rigid cables of 1.5–2.5 mm², single-wire and ultrasonically welded, fine wire cables 1.5 mm² with end sleeves, unmounted with strain relief, can be terminated in situ, 250 V, 16 A.

Two connections per pole, for cables H05VV, NYM (Ø 7.8–10.33 mm), lockable, a lock should be provided for strain relief according to VDE 0628.

Stripping length: 45 mm
Stripped length: 9 mm

Connector part 3-pin, screw connection

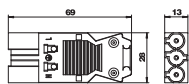

Type	Colour	Pack.	Weight	Item No.
		pcs	kg/100 pcs.	
ST-S GST18i3p SW	Black	1	2.030	6108054
ST-S GST18i3p W	White	1	2.030	6108055

Connector part, 3-pin, type GST18i with screw connection, low height (no slot loss in combination with distributor blocks), for cross-sections of 0.75–2.5 mm², single- and fine-wire cables connectable without end sleeve, for cable diameters between 6.5–10.5 mm (H05VV, NYM), unmounted with strain relief, terminable in situ, 250 V, 16 A.

Stripping length: 31 mm
Insulation removal length: 7 mm

Socket section 3-pin, spring power connection

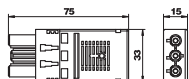

Type	Colour	Pack.	Weight	Item No.
		pcs	kg/100 pcs.	
BT-F GST18i3p SW	Black	1	2.620	6108052
BT-F GST18i3p W	White	1	2.690	6108053

Socket part, 3-pin, type GST18i with spring power connection for rigid cables of 1.5–2.5 mm², single-wire and ultrasonically welded, fine wire cables 1.5 mm² with end sleeves, unmounted with strain relief, can be terminated in situ, 250 V, 16 A.

Two connections per pole, for cables H05VV, NYM (Ø 7.8–10.33 mm), lockable, a lock should be provided for strain relief according to VDE 0628.

Stripping length: 45 mm
Stripped length: 9 mm

Socket section 3-pin, screw connection

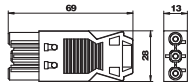

Type	Colour	Pack.	Weight	Item No.
		pcs	kg/100 pcs.	
BT-S GST18i3p SW	Black	1	2.150	6108056
BT-S GST18i3p W	White	1	2.150	6108057

Socket part, 3-pin, type GST18i with screw connection, low height (no slot loss in combination with distributor blocks), for cross-sections of 0.75–2.5 mm², single- and fine-wire cables connectable without end sleeve, for cable diameters between 6.5–10.5 mm (H05VV, NYM), unmounted with strain relief, terminable in situ, 250 V, 16 A.

Stripping length: 31 mm
Insulation removal length: 7 mm

Distributor block 3-pin, 1E/3A

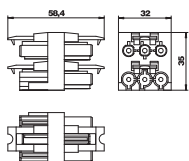

Type	Colour	Pack.	Weight	Item No.
		pcs	kg/100 pcs.	
VB-3 GST18i3p	Black	1	3.590	6108080

Distributor block with lock, type GST18i, one input with plug section 3-pin and three outputs with socket section 3-pin.



Distributor block 3-pin, 1E/5A

Type	Colour	Pack. pcs	Weight kg/100 pcs.	Item No.
VB-5 GST18i3p	Black	1	5.590	6108082

Distributor block with lock, type GST18i, one input with plug section 3-pin and five outputs with socket section 3-pin.

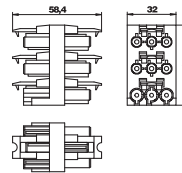

Distributor block, 3-pin, T shaped

Type	Colour	Pack. pcs	Weight kg/100 pcs.	Item No.
VB-T GST18i3p	Black	1	2.540	6108084

T distributor with lock, type GST18i, one input with 3-pin connector part and two outputs with 3-pin socket part.

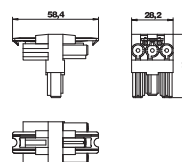

Connector part, 5-pin, screw connection

Type	Colour	Pack. pcs	Weight kg/100 pcs.	Item No.
ST-S GST18i5p SW	Black	1	4.330	6108070

Connector part, 5-pin, type GST18i, with screw connection for 1.5–2.5 mm² cables, single and fine-wire, with strain relief, one connection per pin, unmounted, for cables H05VV (Ø 9.5–13.5) NYM and (Ø 10.5–13.5 mm), lockable, according to the strain relief in VDE 0628 a lock should be planned, 250 V, 16 A.

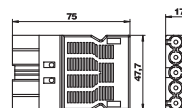

Stripping length: 8 mm
Jacket removal length: 46 mm

Socket section 5-pin, screw connection

Type	Colour	Pack. pcs	Weight kg/100 pcs.	Item No.
BT-S GST18i5p SW	Black	1	4.550	6108072

Socket part, 5-pin, type GST18i, with screw connection for 1.5 to 2.5 mm² cables, single and fine-wire, with strain relief, one connection per pin, unmounted, for cables H05VV (Ø 9.5 – 13.5) NYM and (Ø 10.5 to 13.5 mm), lockable, according to the strain relief in VDE 0628 a lock should be planned, 250 V, 16 A.

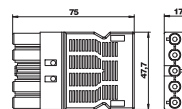

Stripping length: 8 mm
Jacket removal length: 46 mm

Distributor block, 3-pole

Type	Colour	Pack. pcs	Weight kg/100 pcs.	Item No.
VB-2 GST18i3p	Black	1	3.300	6108086

PA Polyamide

Distributor block with lock, type GST18i, 1 input with 3-pin plug section and 2 outputs with 3-pin socket section.

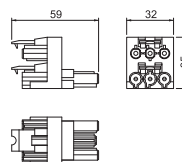

Connector part, 3-pin, screw connection

Type	Colour	Pack. pcs	Weight kg/100 pcs.	Item No.
ST-S4 GST18i3 SW	Black	1	1.600	6108060
ST-S4 GST18i3 W	White	1	1.600	6108062

PA Polyamide

Connector part, 3-pin, type GST18i with screw connection for cables of 1.5–4.0 mm² and cable diameters between 10.5–14.5 mm (H05VV, NYM), unmounted with strain relief, terminable in situ, 250 V, 16 A.

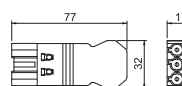

Socket section 3-pin, screw connection

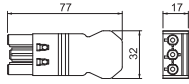

Type	Colour	Pack. Weight		Item No.
		pcs	kg/100 pcs.	
BT-S4 GST18i3 SW	Black	1	1.600	6108064
BT-S4 GST18i3 W	White	1	1.600	6108066

PA Polyamide

Socket section, 3-pin, type GST18i with screw connection for cables of 1.5–4.0 mm² and for cable diameters between 10.5–14.5 mm (H05VV, NYM), unmounted with strain relief, terminable in situ, 250 V, 16 A.

Locking

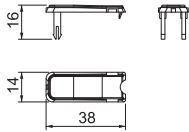

Type	Colour	Pack. Weight		Item No.
		pcs	kg/100 pcs.	
VR-GST18	Black	10	0.100	6108074

PA Polyamide

Locking clip for GST18, plug connections, for locking connection cables.











Modul 45connect® – plug-in installation solutions for raised and cavity floors

The Modul 45connect for underfloor systems is a continuous, connectable installation technology. This is designed for installation in a system floor. Modul 45connect offers the highest level of flexibility, security and cost efficiency.

The system offers all the required installation components: From energy distribution through to device connection in the floor box.



Modul 45connect® – plug-in device installation solutions for raised and cavity floors

	Modul 45connect®, ready-for-connection universal support UTC	80
	Modul 45connect®, sockets and UT universal support	81
	Energy distributor and Consolidation Point	86
	Installation accessories for plug connector systems	91

Ready-for-connection universal support



**HALOGEN
FREE**

Ready-for-connection universal support Connect UTC3 with WIELAND plug connector system GST18. Suitable for the VL connection cables and the device installation units of nominal size 2, 4, R4, 6 and R7. Other variants of the ready-for-connection universal support are possible on request or via self-configuration.

UTC3 with 2 protective contact sockets

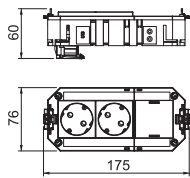

Type	Connection		Pack. pcs	Weight kg/100 pcs.	Item No.
	Circuit	system			
UTC3 G W2	1	GST18	1	16.370	7404662

The ready-for-connection UTC3 universal support possesses two pre-installed 33° protective contact sockets and one blanking cover for reinstallation of one installation device of the Modul 45 or Modul 45connect series.

UTC3 with 3 protective contact sockets

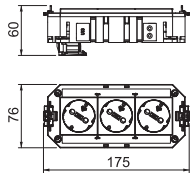

Type	Connection		Pack. pcs	Weight kg/100 pcs.	Item No.
	Circuit	system			
UTC3 G W3	1	GST18	1	19.780	7404664

The ready-for-connection UTC3 universal support possesses three pre-installed 33° protective contact sockets with 16 A.

UTC3 with 2+1 protective contact sockets

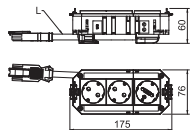

Type	Connection		Pack. pcs	Weight kg/100 pcs.	Item No.
	Circuit	system			
UTC3 G W2OR1	2	GST18	1	26.630	7404660

The ready-for-connection UTC3 universal support possesses two pre-installed 33° protective contact sockets in white and one pre-installed 33° protective contact socket in orange with 16 A.





Ready-for-connection universal support Connect UTC4 with WIELAND plug connector system GST18. Suitable for the VL connection cables and the device installation units of nominal size R7, R9 and 9. Other variants of the ready-for-connection universal support are possible on request or via self-configuration.

UTC4 with 2 protective contact sockets



Type	Connection			Pack. pcs	Weight kg/100 pcs.	Item No.
	Circuit	system	Version			
UTC4 G W2	1	GST18	Double pure white	1	18.500	7404674
UTC4 G OR2	1	GST18	Double pure orange	1	18.460	7404670

The ready-for-connection UTC4 universal support possesses two pre-installed 33° protective contact sockets with 16 A and two blanking covers for reinstallation of two installation devices of the Modul 45 or Modul 45connect series.

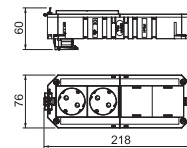

UTC4 with 3 protective contact sockets



Type	Connection			Pack. pcs	Weight kg/100 pcs.	Item No.
	Circuit	system	Version			
UTC4 G W3	1	GST18	Triple pure white	1	21.960	7404680

The ready-for-connection UTC4 universal support possesses three pre-installed 33° protective contact sockets with 16 A and one blanking cover for reinstallation of one installation device of the Modul 45 or Modul 45connect series.

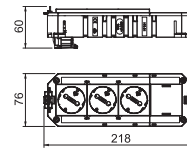

UTC4 with 4 protective contact sockets



Type	Connection			Pack. pcs	Weight kg/100 pcs.	Item No.
	Circuit	system	Version			
UTC4 G W4	1	GST18	4x pure white	1	26.830	7404682
UTC4 G OR4	1	GST18	4x pure orange	1	26.730	7404672

The ready-for-connection UTC4 universal support possesses four pre-installed 33° protective contact sockets with 16 A.

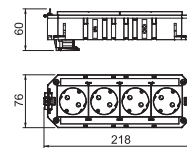

UTC4 with 2+2 protective contact sockets



Type	Connection			Pack. pcs	Weight kg/100 pcs.	Item No.
	Circuit	system	Version			
UTC4 G W2OR2	2	GST18	Double pure white/ Double pure orange	1	27.290	7404676

The ready-for-connection UTC4 universal support possesses two pre-installed 33° protective contact sockets in pure white and two 33° pre-installed protective contact sockets in pure orange with 16 A.

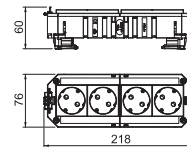

UTC4 with 2+2 protective contact sockets, 2 sockets with surge protection

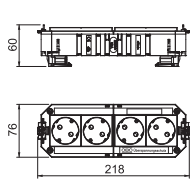

Type	Circuit	Connection		Pack. pcs	Weight kg/100 pcs.	Item No.
		system	Version			
UTC4 G W2OR2 Ü	2	GST18	Double pure white/ Double pure orange	1	31.300	7404678

The ready-for-connection UTC4 universal support possesses two pre-installed 33° protective contact sockets in pure white and two pre-installed 33° protective contact sockets in pure orange with 16 A. The protective contact sockets in pure orange are protected by a Type 3 surge protection module according to DIN EN 61643-11.

UTC4 with 3+1 protective contact sockets

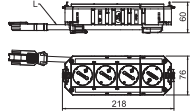

Type	Circuit	Connection		Pack. pcs	Weight kg/100 pcs.	Item No.
		system	Version			
UTC4 G W3OR1	2	GST18	Triple pure white/ Single pure orange	1	29.510	7404684

The ready-for-connection UTC4 universal support possesses three pre-installed 33° protective contact sockets in pure white and one 33° protective contact socket in pure orange with 16 A.

UTC4 with 3+1 protective contact sockets, 1 socket with surge protection

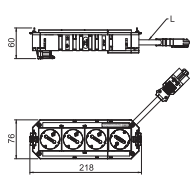

Type	Circuit	Connection		Pack. pcs	Weight kg/100 pcs.	Item No.
		system	Version			
UTC4 G W3OR1 Ü	2	GST18	Triple pure white/ Single pure orange	1	33.530	7404686

The ready-for-connection UTC4 universal support possesses three pre-installed 33° protective contact sockets in white and one 33° protective contact socket in pure orange with 16 A. The protective contact socket in pure orange is protected by a Type 3 surge protection module according to DIN EN 61643-11.

UTC4 with 2+1 protective contact sockets

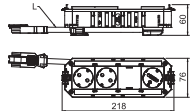

Type	Circuit	Connection		Pack. pcs	Weight kg/100 pcs.	Item No.
		system	Version			
UTC4 G OR2GN1	2	GST18	Double pure orange / Single mint green	1	32.200	7404688

The ready-for-connection UTC4 universal support possesses two pre-installed 33° protective contact sockets in orange and one 33° protective contact socket in mint green with 16 A. A blanking cover allows reinstallation of one installation device of the Modul 45 or Modul 45connect series.

Universal support UT3, system length 165 mm

Type	Length	Installation	Width	Height	Pack.	Weight	Item No.
	mm	technology	mm	mm		pcs	
UT3 45 3	165	Grid M45	76	40	1	10.600	7408723

PA Polyamide

Universal support with two strain reliefs, mounting bridge, partition and UT3 P3 cover plate for installation of 3 Modul 45 devices in device installation units of nominal sizes 2, R4, 4, 6 and R7.

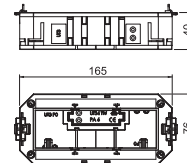

Universal support UT4, system length 208 mm

Type	Length	Width	Height	Pack.	Weight	Item No.
	mm	mm	mm		pcs	
UT4 45 4	208	76	40	1	13.500	7408727

PA Polyamide

Universal support with two strain reliefs, mounting bridges, partition and UT4 P4 cover plate for installation of 4 Modul 45 devices in device installation units of nominal sizes R7, R9 and 9.

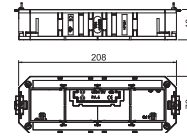

Socket 33°, Connect 45, protective contact, single

Type	Colour		Pack.	Weight	Item No.
	pcs	kg/100 pcs.		pcs.	
STD-D3C GS RW1	Pure white		1	10.500	6120810
STD-D3C GS ROR1	Pure orange		1	10.500	6120812
STD-D3C GS MZGN1	Mint green		1	10.500	6120814
STD-D3C GS SRO1	Signal red		1	10.500	6120816

PC Polycarbonate

Ready-for-connection protective contact socket single 33°, with increased touch protection, incl. 0.25 m connection cable with GST18 connector and locking clip, 16 A, 250 V~.

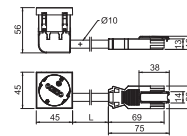

Socket 33°, Connect 45, protective contact, single

Type	Colour		Pack.	Weight	Item No.
	pcs	kg/100 pcs.		pcs.	
STD-D3C GW RW1	Pure white		1	10.500	6120830
STD-D3C GW ROR1	Pure orange		1	10.500	6120832
STD-D3C GW MZGN1	Mint green		1	10.500	6120834
STD-D3C GW SRO1	Signal red		1	10.500	6120836

PC Polycarbonate

Ready-for-connection protective contact socket single 33°, with increased touch protection, incl. 0.25 m connection cable with GST18 connector and locking clip, 16 A, 250 V~.

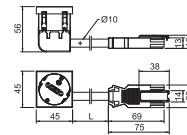

Socket 33°, Connect 45, protective contact, double

Type	Colour		Pack.	Weight	Item No.
	pcs	kg/100 pcs.		pcs.	
STD-D3C RW2	Pure white		1	8.500	6120482
STD-D3C ROR2	Pure orange		1	8.500	6120484
STD-D3C MZGN2	Mint green		1	8.500	6120486
STD-D3C SRO2	Signal red		1	8.500	6120488

PC Polycarbonate

Power socket with side connection double 33°, with increased touch protection with screwless terminals, 2-pin, 16 A, 250 V~, with connection terminals to IEC 60884-1.

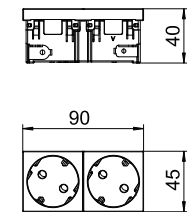

Socket 33°, Connect 45, protective contact, triple

Type	Colour		Pack.	Weight	Item No.
	pcs	kg/100 pcs.		pcs.	
STD-D3C RW3	Pure white		1	11.500	6120502
STD-D3C ROR3	Pure orange		1	11.500	6120504
STD-D3C MZGN3	Mint green		1	11.500	6120506
STD-D3C SRO3	Signal red		1	11.500	6120508

PC Polycarbonate

Power socket with side connection triple 33°, with increased touch protection with screwless terminals, 2-pin, 16 A, 250 V~, with connection terminals to IEC 60884-1.

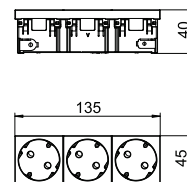

07_EGS_Produnkteilheitenkatalog_EX_2018 / en / 2018/10/08 08:19:15 08:19:15 (LLE:export_02229) / 2018/10/08 08:22:22 08:22:22

Modul 45connect® plug-in installation solutions for raised and cavity floors

Universal support UT3, system length 165 mm

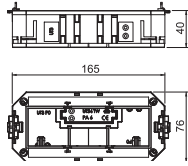

Type	Length	Installation	Width	Height	Pack.	Weight	Item No.
	mm	technology	mm	mm			
UT3 45 3	165	Grid M45	76	40	1	10.600	7408723

PA Polyamide

Universal support with two strain reliefs, mounting bridge, partition and UT3 P3 cover plate for installation of 3 Modul 45 devices in device installation units of nominal sizes 2, R4, 4, 6 and R7.

Universal support UT4, system length 208 mm

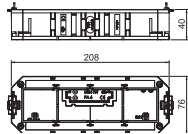

Type	Length	Width	Height	Pack.	Weight	Item No.
	mm	mm	mm			
UT4 45 4	208	76	40	1	13.500	7408727

PA Polyamide

Universal support with two strain reliefs, mounting bridges, partition and UT4 P4 cover plate for installation of 4 Modul 45 devices in device installation units of nominal sizes R7, R9 and 9.

Socket 33°, Connect 45, with earthing pin, single

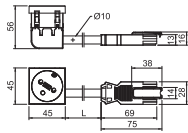

Type	Colour	Pack.	Weight	Item No.
STD-F3C GS RW1	Pure white	1	10.300	6120850
STD-F3C GS ROR1	Pure orange	1	10.300	6120852
STD-F3C GS MZGN1	Mint green	1	10.300	6120854
STD-F3C GS SRO1	Signal red	1	10.300	6120856

PC Polycarbonate

Ready-for-connection protective contact socket single 33°, with increased touch protection, incl. 0.25 m connection cable with GST18 connector and locking clip, 16 A, 250 V~.

Socket 33°, Connect 45, with earthing pin, single

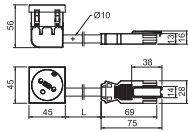

Type	Colour	Pack.	Weight	Item No.
STD-F3C GW RW1	Pure white	1	10.300	6120870
STD-F3C GW ROR1	Pure orange	1	10.300	6120872
STD-F3C GW MZGN1	Mint green	1	10.300	6120874
STD-F3C GW SRO1	Signal red	1	10.300	6120876

PC Polycarbonate

Ready-for-connection protective contact socket single 33°, with increased touch protection, incl. 0.25 m connection cable with GST18 connector and locking clip, 16 A, 250 V~.

Socket 33°, Connect 45, with earthing pin, double

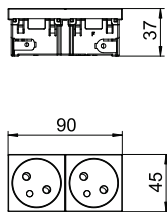

Type	Colour	Pack.	Weight	Item No.
STD-F3C RW2	Pure white	1	8.500	6120672
STD-F3C ROR2	Pure orange	1	8.500	6120674
STD-F3C MZGN2	Mint green	1	8.500	6120676
STD-F3C SRO2	Signal red	1	8.500	6120678

PC Polycarbonate

Socket with earthing pin and side connection, double 33°, with increased touch protection, with screwless terminals, 2-pin, 16 A, 250 V~, with connection terminals to IEC 60884-1.

Socket 33°, Connect 45, with earthing pin, triple

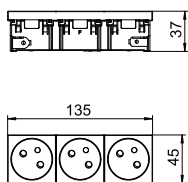

Type	Colour	Pack.	Weight	Item No.
STD-F3C RW3	Pure white	1	11.500	6120692
STD-F3C ROR3	Pure orange	1	11.500	6120694
STD-F3C MZGN3	Mint green	1	11.500	6120696
STD-F3C SRO3	Signal red	1	11.500	6120698
STD-F3C AL3	Aluminium painted	1	11.500	6120702

PC Polycarbonate

Socket with earthing pin and side connection, triple 33°, with increased touch protection, with screwless terminals, 2-pin, 16 A, 250 V~, with connection terminals to IEC 60884-1.

Connection adapter, U-shaped, connector part GST18

Type	Colour	Pack.		Weight	Item No.
		pcs	kg/100 pcs.		
STA-SKS SU1 SW	Black	10	1.190		6117196
STA-SKS SU1 W	White	10	1.190		6117197

PA Polyamide

Connector part adapter, U-shaped, for connection to an STD-D0C / STD-D3C or STD-F0C / STD-F3C socket from the side, for VL extension cable with Wieland connector GST 18i 3p.

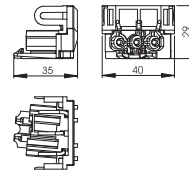

Connection adapter for Modul 45connect® sockets

Type	Colour	Pack.		Weight	Item No.
		pcs	kg/100 pcs.		
VB-SKS S	Black	10	0.590		6117198

PA Polyamide

Connection adapter for combining STD-D0C / STD-D3C or STD-F0C / STD-F3C sockets.

Note: Socket combinations with two connection adapters at most are permitted.

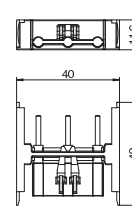

Surge protection module with support



Type	Signalling on device	Pack.		Weight	Item No.
		pcs	kg/100 pcs.		
ÜSM-A-4T	Audible	1	2.226		6107801

2-pin surge protection module, 16 A/250 V~, with acoustic default display, no network switch-off, for connection to a multiple socket of type Modul 45connect using the supplied support. For installation in universal supports UT3/45 and UT4/45. The surge protection module meets EN 61643-11, type 3, Class III, requirements Class D.

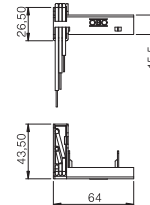

Consolidation Point

CP empty housing

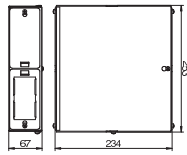

Type

CP45-LG 8A

SI Steel

Consolidation Point empty housing for the installation of 4 Modul 45 accessories (expandable to max. eight Modul 45 accessories), consisting of housing base and cover, a cover hood to separate data technology and heavy current, two support plates for the installation of two Modul 45 accessories each, two blanking plates, two cable glands V-TEC M25 and a protective conductor connection bracket.

Pack. pcs	Weight		Item No.
	kg/100	pcs.	
1	190.000		6108037

CP support plate, for Modul 45® devices, double

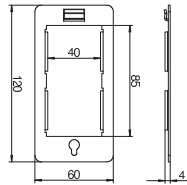
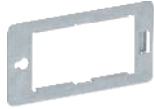

Type

CP45-TP M

SI Steel

Support plate to accept two Modul 45 devices in a Consolidation Point housing.

Pack. pcs	Weight		Item No.
	kg/100	pcs.	
1	4.200		6108039

CP support plate for 3 snap-in plug connectors, 3-pole

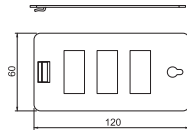

Type

CP45-TP 3SI

SI Steel

Support plate to accept three snap-In connectors, 3-pole, in a Consolidation Point housing.

Pack. pcs	Weight		Item No.
	kg/100	pcs.	
1	6.200		6108024

CP support plate for 4 snap-in plug connectors, 3-pole

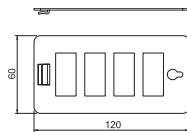

Type

CP45-TP 4SI

SI Steel

Support plate to accept four snap-In connectors, 3-pole, in a Consolidation Point housing.

Pack. pcs	Weight		Item No.
	kg/100	pcs.	
1	5.700		6108026

CP support plate, for 8 data connection modules, type C

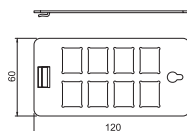

Type

CP45-TP 8C

SI Steel

Support plate, type C, to accept eight data connection modules in a Consolidation Point housing. Type C has a mounting opening of 19.30 x 14.80 mm.

Support plate type C is suitable for accepting the following data connection modules: BTR (Keystone design): Cat.6A Modul und UAE Modul; Corning: Modules with Keystone seat; CobiNet: CobiDat KS module; Dätwyler: KS-T, KS-TS, MS-K and KU-T; EKU: E-Stone; Harting: Prelink Keystone Cat.6A, Fixlink Keystone Cat.6A; Komos: KDM 500 module; Leoni Kerpen: MegaLine-Connect45 socket modules Keystone; OBO: Data connection modules snap-In type ASM-C5 S, ASM-C5 GS, ASM-C6 S, ASM-C6 GS and Keystone type ASM-C6A, ASM-C6A G; R&M: Cat.6A with Keystone fastening; Rutenbeck: UM and UMflex; SETEC: UKJ and XKJ; Telegärtner: AMJ and UMJ.

Pack. pcs	Weight		Item No.
	kg/100	pcs.	
1	5.400		6108028

Terminal strip

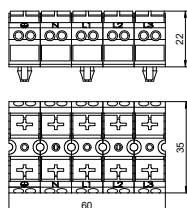

Type

CP45-KL

Screwless terminal strip with locking foot, 5-pin for a cable cross-section of 0.5–4 mm².

Pack. pcs	Weight		Item No.
	kg/100	pcs.	
1	2.000		6108043

UVS energy distributor with fixed connection, normal circuit

Type	Pack. pcs	Weight kg/100 pcs.	Item No.

St Steel

Energy distributor for heavy current technology with fixed connection, equipped and pre-wired.

Input: One 3-phase circuit via a screwless terminal block, 5-pin, for cable cross-sections of 0.5–4 mm².

Output: Six self-locking connectors, 3-pin, in black, 16 A, type GST18i (socket part: 2 x L1, 2 x L2, 2 x L3).

Internal wiring: PVC non-sheathed cable H07V-U2.5.

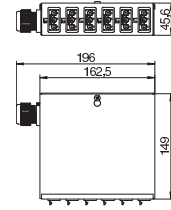

UVS energy distributor with fixed connection, special circuit

Type	Pack. pcs	Weight kg/100 pcs.	Item No.

St Steel

Energy distributor for heavy current technology with fixed connection, equipped and pre-wired.

Input: One 3-phase circuit via a screwless terminal block, 5-pin, for cable cross-sections of 0.5–4 mm².

Output: Six self-locking connectors, 3-pin, in white, 16 A, type GST18i (socket part: 2 x L1, 2 x L2, 2 x L3).

Internal wiring: PVC non-sheathed cable H07V-U2.5.

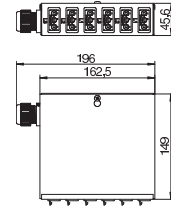

UVS energy distributor with fixed connection, normal and special circuit

Type	Pack. pcs	Weight kg/100 pcs.	Item No.

St Steel

Energy distributor for heavy current technology with fixed connection, equipped and pre-wired.

Input: Two 3-phase circuits via a screwless terminal block, 5-pin, for cable cross-sections of 0.5–4 mm².

Output: Twelve self-locking connectors, 3-pin, in white (6x) and black (6x), 16 A, type GST18i (socket part: 2 x L1, 2 x L2, 2 x L3 for each rotary current circuit).

Internal wiring: PVC non-sheathed cable H07V-U2.5.

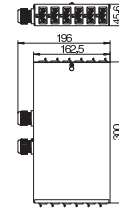

07_EGS_Produnkteilheitenkatalog_EX_2018 / en / 2018/10/08 08:19:15 (LLEExport_02229) / 2018/10/08 08:22:22 08:22:22

Modul 45connect® plug-in installation solutions for raised and cavity floors



UVS energy distributor with plug connection, normal circuit

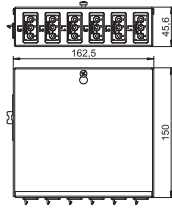

Type

UVS-6S2SA

St Steel

Energy distributor for heavy current technology with plug connection, equipped and pre-wired.

Input: One 3-phase circuit using a self-locking connector, 5-pin, type GST18i (connector part).
Output: Six self-locking connectors, 3-pin, in black, 16 A, type GST18i (socket part: 2 x L1, 2 x L2, 2 x L3).

Internal wiring: PVC non-sheathed cable H07V-U2.5.

Pack. pcs	Weight kg/100 pcs.	Item No.
1	79.000	6108012

UVS energy distributor with plug connection, special circuit

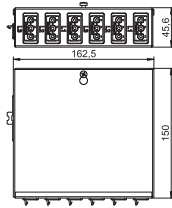

Type

UVS-6W2SA

St Steel

Energy distributor for heavy current technology with plug connection, equipped and pre-wired.

Input: One 3-phase circuit using a self-locking connector, 5-pin, type GST18i (connector part).
Output: Six self-locking connectors, 3-pin, in white, 16 A, type GST18i (socket part: 2 x L1, 2 x L2, 2 x L3).

Internal wiring: PVC non-sheathed cable H07V-U2.5.

Pack. pcs	Weight kg/100 pcs.	Item No.
1	79.000	6108014

UVS energy distributor with plug connection, normal and special circuit



Type

UVS-6S6W2SA

St Steel

Energy distributor for heavy current technology with plug connection, equipped and pre-wired.

Input: Two 3-phase circuits using self-locking connectors, 5-pin, type GST18i (connector part).
Output: Twelve self-locking connectors, 3-pin, in white (6x) and black (6x), 16 A, type GST18i (socket part: 2 x L1, 2 x L2, 2 x L3 for each rotary current circuit).

Internal wiring: PVC non-sheathed cable H07V-U2.5.

Pack. pcs	Weight kg/100 pcs.	Item No.
1	140.000	6108016



3-wire connection cable, PVC, cross-section 1.5 mm², black

Type	Cable length mm	Cross-section mm ²	Number of poles	Colour	Pack. pcs	Weight kg/100 pcs.	Item No.
VL-3Q1.5 1 SW	1000	1.5	3	Black	1	14.000	6108100
VL-3Q1.5 2 SW	2000	1.5	3	Black	1	28.000	6108101
VL-3Q1.5 3 SW	3000	1.5	3	Black	1	42.000	6108102
VL-3Q1.5 4 SW	4000	1.5	3	Black	1	56.000	6108103
VL-3Q1.5 5 SW	5000	1.5	3	Black	1	70.000	6108104
VL-3Q1.5 6 SW	6000	1.5	3	Black	1	84.000	6108105
VL-3Q1.5 7 SW	7000	1.5	3	Black	1	98.000	6108106
VL-3Q1.5 8 SW	8000	1.5	3	Black	1	112.000	6108107
VL-3Q1.5 9 SW	9000	1.5	3	Black	1	126.000	6108108
VL-3Q1.5 10 SW	10000	1.5	3	Black	1	140.000	6108109

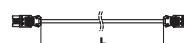

Connection cable 3 x 1.5 mm² in the version socket – connector with GST18i connection system.

3-wire connection cable, PVC, cross-section 1.5 mm², white

Type	Cable length mm	Cross-section mm ²	Number of poles	Colour	Pack. pcs	Weight kg/100 pcs.	Item No.
VL-3Q1.5 1 W	1000	1.5	3	White	1	14.000	6108125
VL-3Q1.5 2 W	2000	1.5	3	White	1	28.000	6108126
VL-3Q1.5 3 W	3000	1.5	3	White	1	42.000	6108127
VL-3Q1.5 4 W	4000	1.5	3	White	1	56.000	6108128
VL-3Q1.5 5 W	5000	1.5	3	White	1	70.000	6108129
VL-3Q1.5 6 W	6000	1.5	3	White	1	84.000	6108130
VL-3Q1.5 7 W	7000	1.5	3	White	1	98.000	6108131
VL-3Q1.5 8 W	8000	1.5	3	White	1	112.000	6108132
VL-3Q1.5 9 W	9000	1.5	3	White	1	126.000	6108133
VL-3Q1.5 10 W	10000	1.5	3	White	1	140.000	6108134

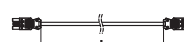

Connection cable 3 x 1.5 mm² in the version socket – connector with GST18i connection system.

3-wire connection cable, halogen-free, cross-section 2.5 mm², white

Type	Cable length mm	Cross-section mm ²	Number of poles	Colour	Pack. pcs	Weight kg/100 pcs.	Item No.
VL-3Q2.5 H1 W	1000	2.5	3	White	1	16.000	6108475
VL-3Q2.5 H2 W	2000	2.5	3	White	1	32.000	6108476
VL-3Q2.5 H3 W	3000	2.5	3	White	1	48.000	6108477
VL-3Q2.5 H4 W	4000	2.5	3	White	1	64.000	6108478
VL-3Q2.5 H5 W	5000	2.5	3	White	1	80.000	6108479
VL-3Q2.5 H6 W	6000	2.5	3	White	1	96.000	6108480
VL-3Q2.5 H7 W	7000	2.5	3	White	1	112.000	6108481
VL-3Q2.5 H8 W	8000	2.5	3	White	1	128.000	6108482
VL-3Q2.5 H9 W	9000	2.5	3	White	1	144.000	6108483
VL-3Q2.5 H10 W	10000	2.5	3	White	1	160.000	6108484

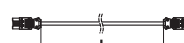

Halogen-free connection cables 3 x 2.5 mm² in the version socket – connector with GST18i connection system.

3-wire connection cable, halogen-free, cross-section 2.5 mm², black

Type	Cable length mm	Cross-section mm ²	Number of poles	Colour	Pack. pcs	Weight kg/100 pcs.	Item No.
VL-3Q2.5 H1 SW	1000	2.5	3	Black	1	16.000	6108450
VL-3Q2.5 H2 SW	2000	2.5	3	Black	1	32.000	6108451
VL-3Q2.5 H3 SW	3000	2.5	3	Black	1	48.000	6108452
VL-3Q2.5 H4 SW	4000	2.5	3	Black	1	64.000	6108453
VL-3Q2.5 H5 SW	5000	2.5	3	Black	1	80.000	6108454
VL-3Q2.5 H6 SW	6000	2.5	3	Black	1	96.000	6108455
VL-3Q2.5 H7 SW	7000	2.5	3	Black	1	112.000	6108456
VL-3Q2.5 H8 SW	8000	2.5	3	Black	1	128.000	6108457
VL-3Q2.5 H9 SW	9000	2.5	3	Black	1	144.000	6108458
VL-3Q2.5 H10 SW	10000	2.5	3	Black	1	160.000	6108459

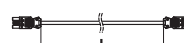

Halogen-free connection cables 3 x 2.5 mm² in the version socket – connector with GST18i connection system.



Connection cables with GST18 connector system

3-wire connection cable, PVC, cross-section 2.5 mm², white



Type	Cable length mm	Cross-section mm ²	Number of poles	Colour	Pack. pcs	Weight kg/100 pcs.	Item No.
VL-3Q2.5 1 W	1000	2.5	3	White	1	18.000	6108175
VL-3Q2.5 2 W	2000	2.5	3	White	1	36.000	6108176
VL-3Q2.5 3 W	3000	2.5	3	White	1	54.000	6108177
VL-3Q2.5 4 W	4000	2.5	3	White	1	72.000	6108178
VL-3Q2.5 5 W	5000	2.5	3	White	1	90.000	6108179
VL-3Q2.5 6 W	6000	2.5	3	White	1	108.000	6108180
VL-3Q2.5 7 W	7000	2.5	3	White	1	126.000	6108181
VL-3Q2.5 8 W	8000	2.5	3	White	1	144.000	6108182
VL-3Q2.5 9 W	9000	2.5	3	White	1	162.000	6108183
VL-3Q2.5 10 W	10000	2.5	3	White	1	180.000	6108184

Connection cable 3 x 2.5 mm² in the version socket – connector with GST18i connection system.

3-wire connection cable, PVC, cross-section 2.5 mm², black

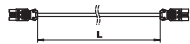

Type	Cable length mm	Cross-section mm ²	Number of poles	Colour	Pack. pcs	Weight kg/100 pcs.	Item No.
VL-3Q2.5 1 SW	1000	2.5	3	Black	1	18.000	6108150
VL-3Q2.5 2 SW	2000	2.5	3	Black	1	36.000	6108151
VL-3Q2.5 3 SW	3000	2.5	3	Black	1	54.000	6108152
VL-3Q2.5 4 SW	4000	2.5	3	Black	1	72.000	6108153
VL-3Q2.5 5 SW	5000	2.5	3	Black	1	90.000	6108154
VL-3Q2.5 6 SW	6000	2.5	3	Black	1	108.000	6108155
VL-3Q2.5 7 SW	7000	2.5	3	Black	1	126.000	6108156
VL-3Q2.5 8 SW	8000	2.5	3	Black	1	144.000	6108157
VL-3Q2.5 9 SW	9000	2.5	3	Black	1	162.000	6108158
VL-3Q2.5 10 SW	10000	2.5	3	Black	1	180.000	6108159

Connection cable 3 x 2.5 mm² in the version socket – connector with GST18i connection system.



Locking

Type	Colour	Pack. pcs	Weight kg/100 pcs.	Item No.
VR-GST18	Black	10	0.100	6108074

PA Polyamide

Locking clip for GST18, plug connections, for locking connection cables.

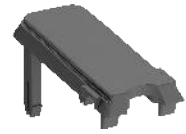
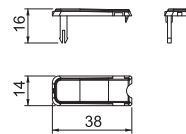

Connector part, 3-pin, screw connection

Type	Colour	Pack. pcs	Weight kg/100 pcs.	Item No.
ST-S GST18i3p SW	Black	1	2.030	6108054
ST-S GST18i3p W	White	1	2.030	6108055

Connector part, 3-pin, type GST18i with screw connection, low height (no slot loss in combination with distributor blocks), for cross-sections of 0.75–2.5 mm², single- and fine-wire cables connectable without end sleeve, for cable diameters between 6.5–10.5 mm (H05VV, NYM), unmounted with strain relief, terminable in situ, 250 V, 16 A.

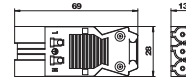

Stripping length: 31 mm
Insulation removal length: 7 mm

Connector part 3-pin, spring power connection

Type	Colour	Pack. pcs	Weight kg/100 pcs.	Item No.
ST-F GST18i3p SW	Black	1	2.600	6108050
ST-F GST18i3p W	White	1	2.620	6108051

Connector part, 3-pin, type GST18i with spring power connection for rigid cables of 1.5–2.5 mm², single-wire and ultrasonically welded, fine wire cables 1.5 mm² with end sleeves, unmounted with strain relief, can be terminated in situ, 250 V, 16 A.

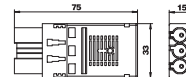

Two connections per pole, for cables H05VV, NYM (Ø 7.8–10.33 mm), lockable, a lock should be provided for strain relief according to VDE 0628.

Stripping length: 45 mm
Stripped length: 9 mm

Socket section 3-pin, screw connection

Type	Colour	Pack. pcs	Weight kg/100 pcs.	Item No.
BT-S GST18i3p SW	Black	1	2.150	6108056
BT-S GST18i3p W	White	1	2.150	6108057

Socket part, 3-pin, type GST18i with screw connection, low height (no slot loss in combination with distributor blocks), for cross-sections of 0.75–2.5 mm², single- and fine-wire cables connectable without end sleeve, for cable diameters between 6.5–10.5 mm (H05VV, NYM), unmounted with strain relief, terminable in situ, 250 V, 16 A.

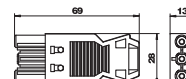

Stripping length: 31 mm
Insulation removal length: 7 mm

Socket section 3-pin, spring power connection

Type	Colour	Pack. pcs	Weight kg/100 pcs.	Item No.
BT-F GST18i3p SW	Black	1	2.620	6108052
BT-F GST18i3p W	White	1	2.690	6108053

Socket part, 3-pin, type GST18i with spring power connection for rigid cables of 1.5–2.5 mm², single-wire and ultrasonically welded, fine wire cables 1.5 mm² with end sleeves, unmounted with strain relief, can be terminated in situ, 250 V, 16 A.

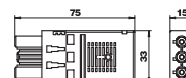

Two connections per pole, for cables H05VV, NYM (Ø 7.8–10.33 mm), lockable, a lock should be provided for strain relief according to VDE 0628.

Stripping length: 45 mm
Stripped length: 9 mm

Connector part, 5-pin, screw connection

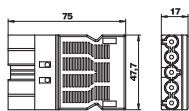

Type	Colour	Pack.	Weight	Item No.
		pcs	kg/100 pcs.	
ST-S GST18i5p SW	Black	1	4.330	6108070

Connector part, 5-pin, type GST18i, with screw connection for 1.5–2.5 mm² cables, single and fine-wire, with strain relief, one connection per pin, unmounted, for cables H05VV (Ø 9.5–13.5) NYM and (Ø 10.5–13.5 mm), lockable, according to the strain relief in VDE 0628 a lock should be planned, 250 V, 16 A.

Stripping length: 8 mm
Jacket removal length: 46 mm

Socket section 5-pin, screw connection

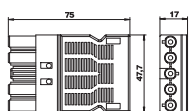

Type	Colour	Pack.	Weight	Item No.
		pcs	kg/100 pcs.	
BT-S GST18i5p SW	Black	1	4.550	6108072

Socket part, 5-pin, type GST18i, with screw connection for 1.5 to 2.5 mm² cables, single and fine-wire, with strain relief, one connection per pin, unmounted, for cables H05VV (Ø 9.5 – 13.5) NYM and (Ø 10.5 to 13.5 mm), lockable, according to the strain relief in VDE 0628 a lock should be planned, 250 V, 16 A.

Stripping length: 8 mm
Jacket removal length: 46 mm

Distributor block, 3-pin, T shaped

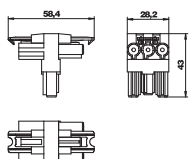

Type	Colour	Pack.	Weight	Item No.
		pcs	kg/100 pcs.	
VB-T GST18i3p	Black	1	2.540	6108084

T distributor with lock, type GST18i, one input with 3-pin connector part and two outputs with 3-pin socket part.

Distributor block 3-pin, 1E/3A

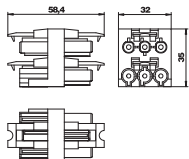

Type	Colour	Pack.	Weight	Item No.
		pcs	kg/100 pcs.	
VB-3 GST18i3p	Black	1	3.590	6108080
VB-5 GST18i3p	Black	1	5.590	6108082

Distributor block with lock, type GST18i, one input with plug section 3-pin and three outputs with socket section 3-pin.

Distributor block, 3-pole

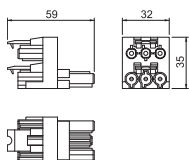

Type	Colour	Pack.	Weight	Item No.
		pcs	kg/100 pcs.	
VB-2 GST18i3p	Black	1	3.300	6108086

Distributor block with lock, type GST18i, 1 input with 3-pin plug section and 2 outputs with 3-pin socket section.

Connector part, 3-pin, screw connection

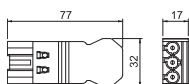

Type	Colour	Pack.	Weight	Item No.
		pcs	kg/100 pcs.	
ST-S4 GST18i3 SW	Black	1	1.600	6108060
ST-S4 GST18i3 W	White	1	1.600	6108062

Connector part, 3-pin, type GST18i with screw connection for cables of 1.5–4.0 mm² and cable diameters between 10.5–14.5 mm (H05VV, NYM), unmounted with strain relief, terminable in situ, 250 V, 16 A.

Socket section 3-pin, screw connection

Type	Colour	Pack. pcs	Weight kg/100 pcs.	Item No.
BT-S4 GST18i3 SW	Black	1	1.600	6108064
BT-S4 GST18i3 W	White	1	1.600	6108066

PA Polyamide

Socket section, 3-pin, type GST18i with screw connection for cables of 1.5–4.0 mm² and for cable diameters between 10.5–14.5 mm (H05VV, NYM), unmounted with strain relief, terminable in situ, 250 V, 16 A.

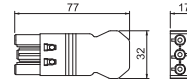



Workplace solutions – Deskboxes and Flexkanal

Deskboxes by OBO offer direct access to power, data and multimedia connections for any workplace and in offices and meeting and conference rooms. For individual requirements, three different Deskbox solutions are available in high-quality materials and elegant designs:

- Freely locatable Deskbox DB
- Lowerable Deskbox DBV
- Foldable Deskbox DBK



Workplace solutions – Deskboxes and Flexkanal

	DB – ready-for-connection Deskbox, freely placeable	96
	DBV – ready-for-connection Deskbox, lowerable	101
	DBK – ready-for-connection Deskbox, foldable	101
	Flexkanal and installation accessories	105

Deskbox DB, freely placeable, 3 sockets

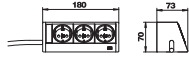

Type	Version	Pack.	Weight	Item No.
		pcs	kg/100 pcs.	
DB-5A3 D3S	Housing, silver anodised	1	66.000	6116930

Alu Aluminium
EL Anodised

Ready-for-connection Deskbox with connection cable, cable outlet on the left housing cover, freely placeable.

Equipment:

- Three protection contact sockets in 0° connection direction, incl. 3.0 m power cable with angular connector CEE 7/7.

Deskbox DB, with fastening clamp, 3 sockets

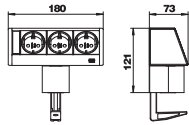

Type	Version	Pack.	Weight	Item No.
		pcs	kg/100 pcs.	
DB-1B3 D3S	Housing, silver anodised	1	102.000	6116930

Alu Aluminium
EL Anodised

Deskbox with connection cable, cable outlet at the bottom of the profile with a fastening clamp for tabletop thicknesses of 8 to 40 mm.

Equipment:

- Three black protection contact sockets in 0° connection direction, incl. 3.0 m power cable with angular connector CEE 7/7.

Deskbox DB, without fastening material, 3 sockets



Type	Version	Pack.	Weight	Item No.
		pcs	kg/100 pcs.	
DB-0B3 D3S	Housing, silver anodised	1	66.000	6116939

Alu Aluminium
EL Anodised

Deskbox with connection cable, cable outlet at the bottom of the profile, without fastening material, combinable with the fastening solutions listed in the accessories.

Equipment:

- Three black protection contact sockets in 0° connection direction, incl. 3.0 m power cable with angular connector CEE 7/7.

Deskbox DB, freely placeable, 3 sockets, 2x RJ45 Cat. 6

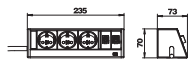

Type	Version	Pack.	Weight	Item No.
		pcs	kg/100 pcs.	
DB-5A3 D3S2K	Housing, silver anodised	1	86.000	6116933

Alu Aluminium
EL Anodised

Deskbox with connection cable, cable outlet on the left and right housing cover, freely placeable using non-slip support points.

Equipment:

- Three black protective contact sockets in 0° connection direction, incl. 3.0 m power cable with angular connector CEE 7/7, cable exit on the left housing cover.
- Two data technology couplings RJ45 to RJ45, 1:1 switched, Cat. 6 shielded, cable exit on the right housing cover.



Deskbox DB, with fastening clamp, 3 switched sockets, 2x RJ45 Cat. 6

Type	Version	Pack. pcs	Weight kg/100 pcs.	Item No.
DB-1B3 D3S2K	Housing, silver anodised	1	122.000	6116942
Alu	Aluminium			
EL	Anodised			

Deskbox with connection cable, cable outlet at the bottom of the profile with two fastening clamps for tabletop thicknesses of 8 to 40 mm.

Equipment:

- Three black protection contact sockets in 0° connection direction, incl. 3.0 m power cable with angular connector CEE 7/7.
- Two data technology couplings RJ45 to RJ45, 1:1 switched, Cat. 6 shielded.

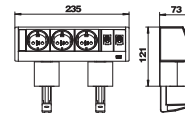

Deskbox DB, without fastening material, 3 sockets, 2x RJ45 Cat. 6

Type	Version	Pack. pcs	Weight kg/100 pcs.	Item No.
DB-0B3 D3S2K	Housing, silver anodised	1	85.700	6116945
Alu	Aluminium			
EL	Anodised			

Deskbox with connection cable, cable outlet at the bottom of the profile, without fastening material, combinable with the fastening solutions listed in the accessories.

Equipment:

- Three black protection contact sockets in 0° connection direction, incl. 3.0 m power cable with angular connector CEE 7/7.
- Two data technology couplings RJ45 to RJ45, 1:1 switched, Cat. 6 shielded.

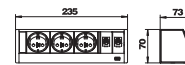

Deskbox DB, freely placeable, 2+2 sockets, 2x RJ45 Cat. 6

Type	Version	Pack. pcs	Weight kg/100 pcs.	Item No.
DB-0A3 D22SR2K	Housing, silver anodised	1	100.000	6116918
Alu	Aluminium			
EL	Anodised			

Deskbox with connection cable, cable outlet on the left and right housing cover, freely placeable using non-slip support points.

Equipment:

- Two black protection contact sockets in 0° connection direction, incl. 3.0 m power cable with angular connector CEE 7/7, cable exit on the left housing cover.
- Two red protection contact sockets in 0° connection direction, incl. 3.0 m power cable with angular connector CEE 7/7, cable exit on the left housing cover.
- Two data technology couplings RJ45 to RJ45, 1:1 switched, Cat. 6 shielded, cable exit on the right housing cover.

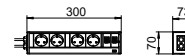

Deskbox DB, with fastening clamp, 1+4 switched sockets

Type	Version	Pack. pcs	Weight kg/100 pcs.	Item No.
DB-1B3 D1.4S	Housing, silver anodised	1	157.000	6116948
Alu	Aluminium			
EL	Anodised			

Deskbox with connection cable, cable outlet at the bottom of the profile with two fastening clamps for tabletop thicknesses of 8 to 40 mm.

Equipment:

- Five black protective contact sockets in 0° connection direction, of which 1 socket is for continuous current and four sockets can be switched using a one-way switch (lit in blue), incl. 3.0 m power cable with angular connector CEE 7/7.

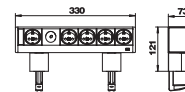

07_EGS_Produnkteilheitenkatalog_EX_2018 / en / 2018/10/08 08:19:15 08:19:15 (LLEExport_02229) / 2018/10/08 08:22:22 08:22:22

Workplace solutions, Deskboxes and Flexkanal



Deskbox DB, without fastening material, 1+4 switched sockets

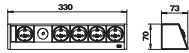

Type	Version	Pack. pcs	Weight kg/100 pcs.	Item No.
DB-0B3 D1.4S	Housing, silver anodised	1	120.000	6116951
Alu	Aluminium			
EL	Anodised			

Deskbox with connection cable, cable outlet at the bottom of the profile, without fastening material, combinable with the fastening solutions listed in the accessories.

Equipment:

- Five black protective contact sockets in 0° connection direction, of which 1 socket is for continuous current and four sockets can be switched using a one-way switch (lit in blue), incl. 3.0 m power cable with angular connector CEE 7/7.

Deskbox DB, with fastening clamp, 1+4 switched sockets, 2x RJ45 Cat. 6

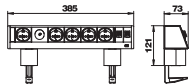

Type	Version	Pack. pcs	Weight kg/100 pcs.	Item No.
DB-1B3 D1.4S2K	Housing, silver anodised	1	177.000	6116954
Alu	Aluminium			
EL	Anodised			

Deskbox with connection cable, cable outlet at the bottom of the profile with two fastening clamps for tabletop thicknesses of 8 to 40 mm.

Equipment:

- Five black protective contact sockets in 0° connection direction, of which 1 socket is for continuous current and four sockets can be switched using a one-way switch (lit in blue), incl. 3.0 m power cable with angular connector CEE 7/7.
- Two data technology couplings RJ45 to RJ45, 1:1 switched, Cat. 6 shielded.

Deskbox DB, without fastening material, 1+4 switched sockets, 2x RJ45 Cat. 6

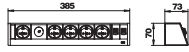

Type	Version	Pack. pcs	Weight kg/100 pcs.	Item No.
DB-0B3 D1.4S2K	Housing, silver anodised	1	140.000	6116957
Alu	Aluminium			
EL	Anodised			

Deskbox with connection cable, cable outlet at the bottom of the profile, without fastening material, combinable with the fastening solutions listed in the accessories.

Equipment:

- Five black protective contact sockets in 0° connection direction, of which 1 socket is for continuous current and four sockets can be switched using a one-way switch (lit in blue), incl. 3.0 m power cable with angular connector CEE 7/7.
- Two data technology couplings RJ45 to RJ45, 1:1 switched, Cat. 6 shielded.

Deskbox DB, with fastening clamp, 3 sockets, VGA, mini jack, USB, 2x RJ45 Cat. 6

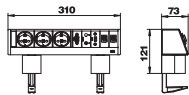

Type	Version	Pack. pcs	Weight kg/100 pcs.	Item No.
DB-M1B3 D3S2K	Housing, silver anodised	1	186.000	6116960
Alu	Aluminium			
EL	Anodised			

Deskbox with connection cable, cable outlet at the bottom of the profile with two fastening clamps for tabletop thicknesses of 8 to 40 mm.

Equipment:

- Three black protection contact sockets in 0° connection direction, incl. 3.0 m power cable with angular connector CEE 7/7.
- One VGA 15-pin HDD socket, incl. 3.0 m connection cable with connector.
- One audio jack socket 3.5 mm, incl. 3.0 m connection cable with connector.
- One USB 2.0, type A socket, incl. 3.0 m connection cable with type A connector.
- Two data technology couplings RJ45 to RJ45, 1:1 switched, Cat. 6 shielded.



Deskbox DB, without fastening material, 3 sockets, VGA, mini jack, USB, 2x RJ45 Cat. 6

Type	Version	Pack. pcs	Weight kg/100 pcs.	Item No.
DB-M0B3 D3S2K	Housing, silver anodised	1	150.000	6116963

- Alu** Aluminium
- EL** Anodised

Deskbox with connection cable, cable outlet at the bottom of the profile, without fastening material, combinable with the fastening solutions listed in the accessories.

Equipment:

- Three black protection contact sockets in 0° connection direction, incl. 3.0 m power cable with angular connector CEE 7/7.
- One VGA 15-pin HDD socket, incl. 3.0 m connection cable with connector.
- One audio jack socket 3.5 mm, incl. 3.0 m connection cable with connector.
- One USB 2.0, type A socket, incl. 3.0 m connection cable with type A connector.
- Two data technology couplings RJ45 to RJ45, 1:1 switched, Cat. 6 shielded.



Deskbox DB, with fastening clamp, 3 sockets, HDMI, USB 3.0, 2x RJ45 Cat. 6

Type	Version	Pack. pcs	Weight kg/100 pcs.	Item No.
DB-MH1B3 D3S2K	Housing, silver anodised	1	186.000	6116961

- Alu** Aluminium
- EL** Anodised

Deskbox with connection cable, cable outlet at the bottom of the profile with two fastening clamps for tabletop thicknesses of 8 to 40 mm.

Equipment:

- Three black protection contact sockets in 60° connection direction, incl. 3.0 m power cable with angular connector CEE 7/7.
- One HDMI 1.3 socket, including 3.0 m connection cable with connector.
- One USB 3.0, type A socket, including 3.0 m connection cable with connector type A.
- Two data technology coupling RJ45 on RJ45, 1:1 switched, Cat. 6 shielded.

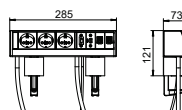

Fastening clamp for Deskbox DB

Type	Colour	Version	Pack. pcs	Weight kg/100 pcs.	Item No.
DBZ-BZ40	Black	Clamping range 8 to 40 mm	1	18.000	6116976
DBZ-BZ75	Black	Clamping range 40 to 75 mm	1	20.000	6116979

Fastening clamp for mounting a Deskbox type DB-... on the tabletop.

Note: For housing widths of 200 mm or more, two fastening clamps are required to mount a Deskbox.

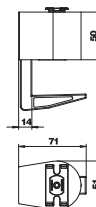

Stainless steel fastening stand for Deskbox DB

Type	Pack. pcs	Weight kg/100 pcs.	Item No.
DBZ-BFE	1	34.000	6116982

Stainless steel fastening stand for fixed mounting of a Deskbox type DB-... on a tabletop. It is mounted using a drill hole (Ø16 mm) in the tabletop.

Note: Can be used in tabletops of up to 50 mm thickness.

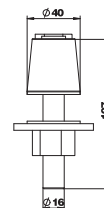

Fastening set for table mounting, for Deskbox DB

Type	Pack. pcs	Weight kg/100 pcs.	Item No.
DBZ-BST	1	2.300	6116985

Fastening set for fixed mounting of Deskbox type DB-... on the tabletop. It is mounted using a drill hole (Ø10 mm) in the tabletop.

Note: The included fastening screws (M4 x 40 mm) can be used for tabletops of up to a maximum thickness of 32 mm.

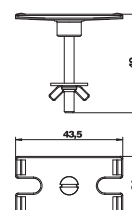

DB – Ready-for-connection Deskbox, freely placeable

Fastening set for under-table mounting, for Deskbox DB

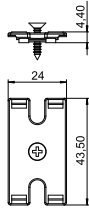

Type
DBZ-BSUT

Pack.	Weight	Item No.
pcs	kg/100 pcs.	
1	100.000	6116986

Fastening set for fixed mounting of Deskbox type DB-... under the tabletop. It is mounted on the tabletop using two wood screws.

Flexkanal holder for Deskbox DB

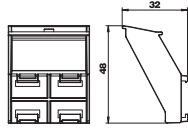

Type
DBZ-FLKB Black

Pack.	Weight	Item No.
pcs	kg/100 pcs.	
1	1.100	6116991

Flexkanal holder for Deskbox, type DB, for secure connection of a Flexkanal to the Deskbox.

Note: Can only be used for mounting on the tabletop using fastening clamps.



Deskbox DBV, 2 sockets

Type	Pack.	Weight	Item No.
	pcs	kg/100 pcs.	
DBV-A3A D2S	1	93.230	6116854
DBV-A3E D2S	1	99.230	6116858

- Alu Aluminium
- EL Anodised

Lowerable Deskbox with connection cable for fixed installation on a tabletop, plastic fastening sleeve, painted accordingly in cover shade. It is mounted using a drill hole (Ø102 mm) in the tabletop.

Equipment:

- Two black protection contact sockets in 60° connection direction, incl. 3.0 m power cable with angular connector CEE 7/7.

Note: Can be used in tabletops of up to 50 mm thickness.

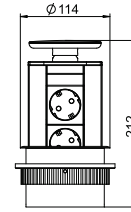

Deskbox DBV, 3 sockets

Type	Pack.	Weight	Item No.
	pcs	kg/100 pcs.	
DBV-A3A D3S	1	98.230	6116862
DBV-A3E D3S	1	106.230	6116866

- Alu Aluminium
- EL Anodised

Lowerable Deskbox with connection cable for fixed installation on a tabletop, plastic fastening sleeve, painted accordingly in cover shade. It is mounted using a drill hole (Ø102 mm) in the tabletop.

Equipment:

- Three black protection contact sockets in 60° connection direction, incl. 3.0 m power cable with angular connector CEE 7/7.

Note: Can be used in tabletops of up to 50 mm thickness.

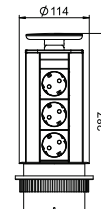

Deskbox DBV, 2 sockets, 2x RJ45 Cat. 6

Type	Pack.	Weight	Item No.
	pcs	kg/100 pcs.	
DBV-A3A D2S2K	1	98.230	6116870
DBV-A3E D2S2K	1	106.230	6116874

- Alu Aluminium
- EL Anodised

Lowerable Deskbox with connection cable for fixed installation on a tabletop, plastic fastening sleeve, painted accordingly in cover shade. It is mounted using a drill hole (Ø102 mm) in the tabletop.

Equipment:

- Two black protection contact sockets in 60° connection direction, incl. 3.0 m power cable with angular connector CEE 7/7.
- Two data technology couplings RJ45 to RJ45, 1:1 switched, Cat. 6 shielded.

Note: Can be used in tabletops of up to 50 mm thickness.

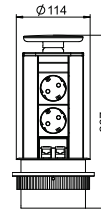

07_EGS_Produkteinheitenkatalog_EX_2018 / en / 2018/10/08 08:19:15 (LLE:export_02229) / 2018/10/08 08:22:22 08:22:22



Deskbox DBV, 3 sockets, 2x RJ45 Cat. 6

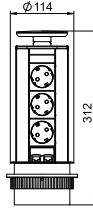

Type

DBV-A3A D3S2K	1	103.230	6116878
DBV-A3E D3S2K	1	111.230	6116882

Pack. pcs	Weight kg/100 pcs.	Item No.
1	103.230	6116878
1	111.230	6116882

- Alu Aluminium
- EL Anodised

Lowerable Deskbox with connection cable for fixed installation on a tabletop, plastic fastening sleeve, painted accordingly in cover shade. It is mounted using a drill hole (Ø102 mm) in the tabletop.

Equipment:

- Three black protection contact sockets in 60° connection direction, incl. 3.0 m power cable with angular connector CEE 7/7.
- Two data technology couplings RJ45 to RJ45, 1:1 switched, Cat. 6 shielded.

Note: Can be used in tabletops of up to 50 mm thickness.

Deskbox DBV, 2 sockets, VGA, mini jack, 2x RJ45 Cat. 6

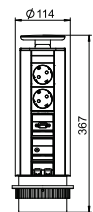

Type

DBV-MA3A D3S2K	1	118.230	6116886
DBV-MA3E D3S2K	1	126.230	6116890

Pack. pcs	Weight kg/100 pcs.	Item No.
1	118.230	6116886
1	126.230	6116890

- Alu Aluminium
- EL Anodised

Lowerable Deskbox with connection cable for fixed installation on a tabletop, plastic fastening sleeve, painted accordingly in cover shade. It is mounted using a drill hole (Ø102 mm) in the tabletop.

Equipment:

- Two black protection contact sockets in 60° connection direction, incl. 3.0 m power cable with angular connector CEE 7/7.
- One VGA 15-pin HDD socket, incl. 3.0 m connection cable with connector.
- One audio jack socket 3.5 mm, incl. 3.0 m connection cable with connector.
- Two data technology couplings RJ45 to RJ45, 1:1 switched, Cat. 6 shielded.

Note: Can be used in tabletops of up to 50 mm thickness.

Deskbox DBV, 2 sockets, HDMI, 2x RJ45 Cat. 6

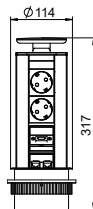

Type

DBV-MHA3A D2S2K	1	108.230	6116887
DBV-MHA3E D2S2K	1	116.230	6116888

Pack. pcs	Weight kg/100 pcs.	Item No.
1	108.230	6116887
1	116.230	6116888

- Alu Aluminium
- EL Anodised

Lowerable Deskbox with connection cable for fixed installation on a tabletop, plastic fastening sleeve, painted accordingly in cover shade. It is mounted using a drill hole (Ø102 mm) in the tabletop.

Equipment:

- Two black protection contact sockets in 60° connection direction, incl. 3.0 m power cable with angular connector CEE 7/7.
- One HDMI 1.3 socket, including 3.0 m connection cable with connector.
- Two data technology couplings RJ45 to RJ45, 1:1 switched, Cat. 6 shielded.

Note: Can be used in tabletops of up to 60 mm thickness.

Circular band saw for Deskbox DBV

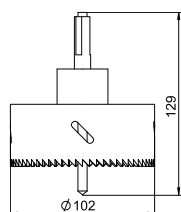

Type

DBZ-LS	1	100.000	6116994
---------------	---	---------	----------------

Pack. pcs	Weight kg/100 pcs.	Item No.
1	100.000	6116994

Circular band saw as a mounting tool for precise installation of a Deskbox of type DBV, drill hole diameter 102 mm.



Deskbox DBK, 3 sockets

Type	Pack.		Weight	Item No.
	pcs	kg/100 pcs.		
DBK2-E3 D3S	1	133.860		6116800

V2A Stainless steel, grade 304

Foldable Deskbox with connection cable for fixed installation in a tabletop, housing made of brushed stainless steel with brush bar as cable outlet. It is mounted using a 195 x 157 mm installation opening in the tabletop.



Equipment:

- Three black protective contact sockets in 60° connection direction, incl. 3.0 m power cable with angular connector CEE 7/7.

Note: Can be used in tabletops of up to 50 mm thickness.

Deskbox DBK, 4 sockets

Type	Pack.		Weight	Item No.
	pcs	kg/100 pcs.		
DBK2-E4 D4S	1	163.860		6116804

V2A Stainless steel, grade 304

Foldable Deskbox with connection cable for fixed installation in a tabletop, housing made of brushed stainless steel with brush bar as cable outlet. It is mounted using a 245 x 157 mm installation opening in the tabletop.



Equipment:

- Four black protective contact sockets in 60° connection direction, incl. 3.0 m power cable with angular connector CEE 7/7.

Note: Can be used in tabletops of up to 50 mm thickness.

Deskbox DBK, 2 sockets, 2x RJ45 Cat. 6

Type	Pack.		Weight	Item No.
	pcs	kg/100 pcs.		
DBK2-D3 D2S2K	1	178.800		6116802

V2A Stainless steel, grade 304

Foldable Deskbox with connection cable for fixed installation in a tabletop, housing made of brushed stainless steel with brush bar as cable outlet. It is mounted using a 195 x 157 mm installation opening in the tabletop.



Equipment:

- Two black protective contact sockets in 60° connection direction, incl. 3.0 m power cable with angular connector CEE 7/7.
- Two data technology couplings RJ45 to RJ45, 1:1 switched, Cat. 6 shielded.

Note: Can be used in tabletops of up to 50 mm thickness.

Deskbox DBK, 3 sockets, 2x RJ45 Cat. 6

Type	Pack.		Weight	Item No.
	pcs	kg/100 pcs.		
DBK2-D4 D3S2K	1	163.860		6116806

V2A Stainless steel, grade 304

Foldable Deskbox with connection cable for fixed installation in a tabletop, housing made of brushed stainless steel with brush bar as cable outlet. It is mounted using a 245 x 157 mm installation opening in the tabletop.



Equipment:

- Three black protective contact sockets in 60° connection direction, incl. 3.0 m power cable with angular connector CEE 7/7.
- Two data technology couplings RJ45 to RJ45, 1:1 switched, Cat. 6 shielded.

Note: Can be used in tabletops of up to 50 mm thickness.



Deskbox DBK, 3 sockets, VGA, mini jack, 2x RJ45 Cat. 6



Type

DBK2-M5V D3S2K

Pack. pcs	Weight kg/100 pcs.	Item No.
1	278.000	6116808

V2A Stainless steel, grade 304

Foldable Deskbox with connection cable for fixed installation in a tabletop, housing made of brushed stainless steel with brush bar as cable outlet. It is mounted using a 295 x 157 mm installation opening in the tabletop.

Equipment:

- Three black protective contact sockets in 60° connection direction, incl. 3.0 m power cable with angular connector CEE 7/7.
- One VGA 15-pin HDD socket, incl. 3.0 m connection cable with connector.
- One audio jack socket 3.5 mm, incl. 3.0 m connection cable with connector.
- Two data technology couplings RJ45 to RJ45, 1:1 switched, Cat. 6 shielded.

Note: Can be used in tabletops of up to 50 mm thickness.

Deskbox DBK, 2 sockets, HDMI, 2x RJ45 Cat. 6



Type

DBK2-M4H D2S2K

Pack. pcs	Weight kg/100 pcs.	Item No.
1	173.760	6116810

V2A Stainless steel, grade 304

Foldable Deskbox with connection cable for fixed installation in a tabletop, housing made of brushed stainless steel with brush bar as cable outlet. It is mounted using a 245 x 157 mm installation opening in the tabletop.

Equipment:

- Two black protective contact sockets in 60° connection direction, incl. 3.0 m power cable with angular connector CEE 7/7.
- One HDMI 1.3 socket, including 3.0 m connection cable with connector.
- Two data technology couplings RJ45 to RJ45, 1:1 switched, Cat. 6 shielded.

Note: Can be used in tabletops of up to 50 mm thickness.



Flexkanal

Type	Length		Colour	Pack. m	Weight		Item No.
	mm				kg/100 m		
FLK-2K LGR	1000		Light grey	1	28.800		6154922
FLK-2K SWGR	1000		Black-grey	1	28.800		6154930



The Flexkanal runs your cables ordered and protected to the desk. It connects the Deskbox with the dado duct or with the floor connection box. When extended, the Flexkanal is 1,000 mm long, 60 mm wide and 20 mm high.

The duct consists of two chambers, capacity per chamber: two cables of 8.5 mm diameter or three cables of 7.5 mm diameter or four cables of 7.0 mm diameter or five cables of 6.0 mm diameter.

Holder with strain relief for Flexkanal

Type	Colour	Pack. pcs	Weight		Item No.
			kg/100 pcs.		
FLK-HL ZL	Anthracite grey	1	10.500		6154961

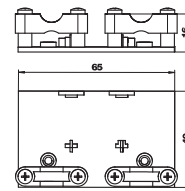

The holder possesses two integrated strain reliefs and can be screwed on. A Flexkanal can be mounted directly on the holder.

Fastening clamp for Flexkanal

Type	Material	Pack. pcs	Weight		Item No.
			kg/100 pcs.		
FLK-BEF	Alu	1	0.150		6154968

Alu Aluminium

The Flexkanal is suspended from the fastening clamp. The holder is fastened using a countersunk union.

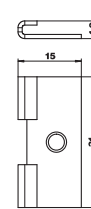

Floor rail for Flexkanal

Type	Length		Colour	Pack. pcs	Weight		Item No.
	mm				kg/100 pcs.		
FLK-BS1	1000		Anthracite grey	1	19.400		6154980
FLK-BS2	2000		Anthracite grey	1	19.400		6154983

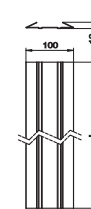

The Flexkanal is pushed directly into the floor rail. The ramp on both sides reduces the risk of stumbling.

T branch for Flexkanal

Type	Colour	Pack. pcs	Weight		Item No.
			kg/100 pcs.		
FLK-TAZ	Anthracite grey	1	8.700		6154965

T branch for supply of working places with the Flexkanal.

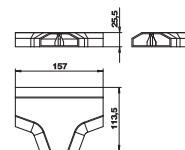

Fastening bracket for Flexkanal in GES service outlet with 5 mm floor covering recess

Type	Material symbol	Pack. pcs	Weight		Item No.
			kg/100 pcs.		
FKH GES5	St	1	1.200		7407860

St Steel

P Powder-coated

Fastening bracket to connect a Flexkanal to a GES service outlet with 5 mm floor covering recess. Dimension h = 43 mm.

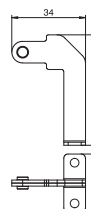

Fastening bracket for Flexkanal in GESRM2 service outlets

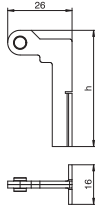

Type	Material symbol	Pack. pcs	Weight kg/100 pcs.	Item No.
FKH GESRM	St	1	1.500	7407864
St	Steel			
P	Powder-coated			

Fixing bracket to connect a Flexkanal to the service outlet GESRM2.







Modul 45[®] and Standard – suspended power supply units VH/VHF

Suspended energy distributors for workplaces and machines in industry, the trades and in training areas. The power supply units can be positioned freely in the room. The supply comes from the ceiling. They can be equipped flexibly, with power, data and media technology through to work media such as compressed air.



Modul 45® and Standard – suspended power supply units VH/VHF

	VH – prewired power supply units IP20	110
	VH – empty housing and installation accessories IP20	112
	VH – empty housing and installation accessories IP20, pure white	115
	VH – device installation solutions for empty housing IP20	116
	VHF – empty housing and installation accessories IP44	119
	VH – device installation solutions for empty housing IP44	121
	Fastening solutions for power supply units VH and VHF	122



VH-4 power supply unit, 4x protective contact socket

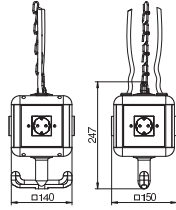

Type	Colour	Pack. Weight		Item No.
		pcs	kg/100 pcs.	
VH-4 4SD	Graphite black	1	95.000	6109802

PA Polyamide

Housing equipped and pre-wired with suspension lug, grip hook and four cover plates.

Equipped as follows: 4 x single protective contact sockets 16 A/250 V with increased touch protection, pre-wired for two AC currents, connection via 2 x 3-pin terminals, 1 x CEE socket 16 A/415 V, with partition for circuit separation.

VH-4 power supply unit, 3x protective contact socket, 1x CEE 16 A

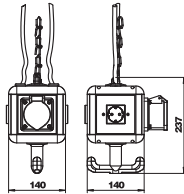

Type	Colour	Pack. Weight		Item No.
		pcs	kg/100 pcs.	
VH-4 3SD1C16	Graphite black	1	115.700	6109804

PA Polyamide

Housing equipped and pre-wired with suspension lug, grip hook and four cover plates.

Equipped as follows: 3 x single protective contact sockets 16 A/250 V with increased touch protection, pre-wired for an AC current, connection via 1 x 3-pin terminal, 1 x CEE socket 16 A/415 V, with partition for circuit separation.

VH-4 power supply unit, 4x earthing pin socket

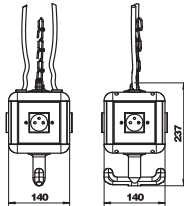

Type	Colour	Pack. Weight		Item No.
		pcs	kg/100 pcs.	
VH-4 4SF	Graphite black	1	95.000	6109806

PA Polyamide

Housing equipped and pre-wired with suspension lug, grip hook and four cover plates.

Equipped as follows: 4 x single sockets with earthing pin 16 A/250 V with increased touch protection, pre-wired for two AC currents, connection via 2 x 3-pin terminals, 1 x CEE socket 16 A/415 V, with partition for circuit separation.

VH-4 power supply unit, 3x earthing pin socket, 1x CEE 16 A

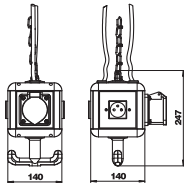

Type	Colour	Pack. Weight		Item No.
		pcs	kg/100 pcs.	
VH-4 3SF1C16	Graphite black	1	115.700	6109808

PA Polyamide

Housing equipped and pre-wired with suspension lug, grip hook and four cover plates.

Equipped as follows: 3 x single sockets with earthing pin 16 A/250 V with increased touch protection, pre-wired for an AC current, connection via 1 x 3-pin terminal, 1 x CEE socket 16 A/415 V, with partition for circuit separation.

VH-4 power supply unit, 4x protective contact socket, with compressed air connection

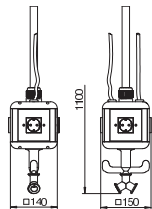

Type	Colour	Pack. Weight		Item No.
		pcs	kg/100 pcs.	
VH-4L 4SD	Graphite black	1	428.600	6109812

PA Polyamide

Housing equipped and pre-wired, with 1 m pipe 1/2" and connection for compressed air hose 13 x 3.5 mm and 2-way distributor 1/2", with suspension lug, grip hook and four cover plates.

Equipped as follows: 4 x single protective contact sockets 16 A/250 V with increased touch protection, pre-wired for two AC currents, connection via 2 x 3-pin terminals, 1 x CEE socket 16 A/415 V, with partition for circuit separation.

VH-4 power supply unit, 3x protective contact socket, 1x CEE 16 A, with compressed air connection

Type	Colour	Pack. pcs	Weight kg/100 pcs.	Item No.
VH-4L 3SD1C16	Graphite black	1	380.000	6109814

PA Polyamide

Housing equipped and pre-wired, with 1 m pipe 1/2" and connection for compressed air hose 13 x 3.5 mm and 2-way distributor 1/2", with suspension lug, grip hook and four cover plates.

Equipped as follows: 3 x single protective contact sockets 16 A/250 V with increased touch protection, pre-wired for an AC current, connection via 1 x 3-pin terminal, 1 x CEE socket 16 A/415 V, with partition for circuit separation.

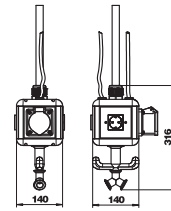

VH-4 power supply unit, 4x earthing pin socket, with compressed air connection

Type	Colour	Pack. pcs	Weight kg/100 pcs.	Item No.
VH-4L 4SF	Graphite black	1	428.600	6109816

PA Polyamide

Housing equipped and pre-wired, with 1 m pipe 1/2" and connection for compressed air hose 13 x 3.5 mm and 2-way distributor 1/2", with suspension lug, grip hook and four cover plates.

Equipped as follows: 4 x single sockets with earthing pin 16 A/250 V with increased touch protection, pre-wired for two AC currents, connection via 2 x 3-pin terminals, 1 x CEE socket 16 A/415 V, with partition for circuit separation.

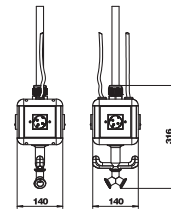

VH-4 power supply unit, 3x earthing pin socket, 1x CEE 16 A, with compressed air connection

Type	Colour	Pack. pcs	Weight kg/100 pcs.	Item No.
VH-4L 3SF1C16	Graphite black	1	440.000	6109818

PA Polyamide

Housing equipped and pre-wired, with 1 m pipe 1/2" and connection for compressed air hose 13 x 3.5 mm and 2-way distributor 1/2", with suspension lug, grip hook and four cover plates.

Equipped as follows: 3 x single sockets with earthing pin 16 A/250 V with increased touch protection, pre-wired for an AC current, connection via 1 x 3-pin terminal, 1 x CEE socket 16 A/415 V, with partition for circuit separation.

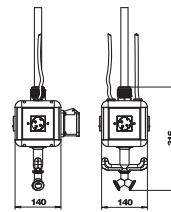

VH-4 power supply unit, empty housing

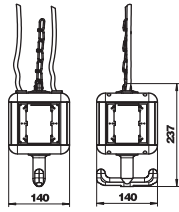

Type	Colour	Pack. Weight		Item No.
		pcs	kg/100 pcs.	
VH-4 LG	Graphite black	1	62.000	6109800

PA Polyamide

Empty housing with suspension lug and grip hook, for the installation of four electrical resources, with included partition. Without cover plates.

VH-4 power supply unit, empty housing, with compressed air connection

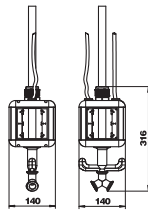

Type	Colour	Pack. Weight		Item No.
		pcs	kg/100 pcs.	
VH-4L LG	Graphite black	1	343.800	6109810

PA Polyamide

Empty housing with 1 m pipe 1/2" and connection for compressed air hose 13 x 3.5 mm and 2-way distributor 1/2". With suspension lug and grip hook, for the installation of four electrical resources, with included partition. Without cover plates.

VH-8 power supply unit, empty housing

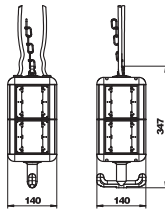

Type	Colour	Pack. Weight		Item No.
		pcs	kg/100 pcs.	
VH-8 LG	Graphite black	1	88.200	6109821

PA Polyamide

Empty housing with suspension lug and grip hook, for the installation of eight electrical resources, with included partition. Without cover plates.

VH-8 power supply unit, empty housing, with cover plates

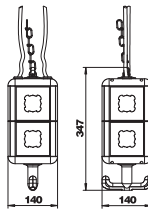

Type	Colour	Pack. Weight		Item No.
		pcs	kg/100 pcs.	
VH-8 LG8P2	Graphite black	1	123.400	6109820

PA Polyamide

Empty housing with suspension lug and grip hook, for the installation of eight electrical resources, with included partition. With eight cover plates for accessories with concealed support ring or support bracket.

VH-8 power supply unit, empty housing, with compressed air connection

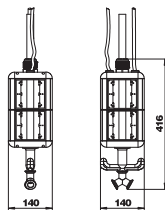

Type	Colour	Pack. Weight		Item No.
		pcs	kg/100 pcs.	
VH-8L LG	Graphite black	1	300.000	6109825

PA Polyamide

Empty housing with 1 m pipe 1/2" and connection for compressed air hose 13 x 3.5 mm and 2-way distributor 1/2". With suspension lug and grip hook, for the installation of electrical resources, with included partition. Without cover plates.

Partition VH-4

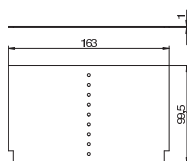

Type	Colour	Pack. Weight		Item No.
		pcs	kg/100 pcs.	
VH-4 TW	Graphite black	1	2.350	6109832

PVC Polyvinylchloride

Additional partition wall for reciprocal insulation of three different power circuits and types. Version for VH-4.

Partition VH-8

Type	Colour	Pack. pcs	Weight kg/100 pcs.	Item No.
VH-8 TW	Graphite black	1	4.890	6109862

PVC Polyvinylchloride

Additional partition wall for reciprocal insulation of three different power circuits and types. Version for VH-8.

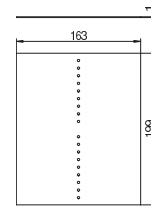

Cover plate VH, for EK and EKR devices

Type	Colour	Pack. pcs	Weight kg/100 pcs.	Item No.
VH-P2	Rape yellow	1	2.300	6109834

PA Polyamide

Cover plate with opening \varnothing 45 mm for the installation of a device with concealed support ring or support clamp.

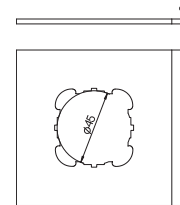

Cover plate VH, for Modul 45 devices, single

Type	Colour	Pack. pcs	Weight kg/100 pcs.	Item No.
VH-P4	Rape yellow	1	2.030	6109840

PA Polyamide

Cover plate to install a single Modul 45 socket.

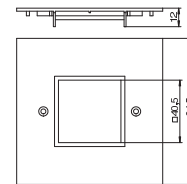

Cover plate VH, for Modul 45 devices, double

Type	Colour	Pack. pcs	Weight kg/100 pcs.	Item No.
VH-P5	Rape yellow	1	1.830	6109836

PA Polyamide

Cover plate to install a double Modul 45 socket.

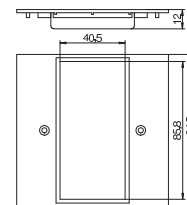

Cover plate VH, for 1x extension socket, type ASD

Type	Colour	Pack. pcs	Weight kg/100 pcs.	Item No.
VH-P7	Rape yellow	1	1.890	6109839

PA Polyamide

Cover plate with opening for the installation of a socket with 38 x 38 mm fastening system.

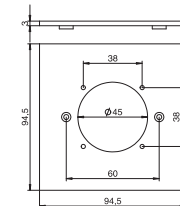

Cover plate VH, for CEE connection unit

Type	Colour	Pack. pcs	Weight kg/100 pcs.	Item No.
VH-P3	Rape yellow	1	1.870	6109838

PA Polyamide

Cover plate with a \varnothing 70 mm opening for the installation of a CEE socket 16/32 A with 60 mm fastening track, including four fastening screws.

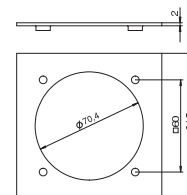

Information on equipment:

Max. 2 CEE sockets 16/32 A in a power supply unit VH-4

Max. 4 CEE sockets 16/32 A in a power supply unit VH-8



VH cover plate as blanking cover

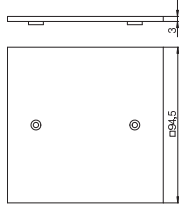

Colour		Pack.	Weight	Item No.
Type		pcs	kg/100 pcs.	
VH-P1	Rape yellow	1	3.000	6109842
PA	Polyamide			

Cover plate as blanking cover.



VH4 power supply unit, empty housing

Type	Colour	Pack. pcs	Weight kg/100 pcs.	Item No.
VH-4 LG RW	Pure white	1	72.000	6109801
PA	Polyamide			

Empty housing with suspension lug and grip hook, for the installation of four electrical resources, with included partition. Without cover plates.

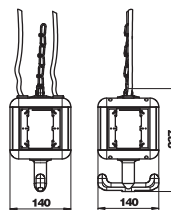

Cover plate VH, for Modul 45 devices, single

Type	Colour	Pack. pcs	Weight kg/100 pcs.	Item No.
VH-P4 RW	Pure white	1	2.000	6109841
PA	Polyamide			

Cover plate to install a single Modul 45 socket.

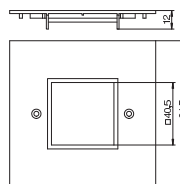

Cover plate VH, for Modul 45 devices, double

Type	Colour	Pack. pcs	Weight kg/100 pcs.	Item No.
VH-P5 RW	Pure white	1	1.830	6109835
PA	Polyamide			

Cover plate to install a double Modul 45 socket.

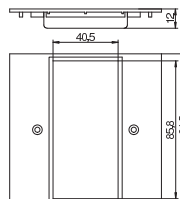

Cover plate VH, for CEE connection unit

Type	Colour	Pack. pcs	Weight kg/100 pcs.	Item No.
VH-P3 RW	Pure white	1	2.000	6109837
PA	Polyamide			

Cover plate with a Ø 70 mm opening for the installation of a CEE socket 16/32 A with 60 mm fastening track, including four fastening screws.

Information on equipment:

Max. 2 CEE sockets 16/32 A in a power supply unit VH-4

Max. 4 CEE sockets 16/32 A in a power supply unit VH-8

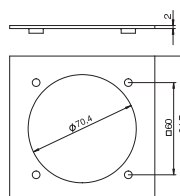

VH cover plate as blanking cover

Type	Colour	Pack. pcs	Weight kg/100 pcs.	Item No.
VH-P1 RW	Pure white	1	3.000	6109843
PA	Polyamide			

Cover plate as blanking cover.

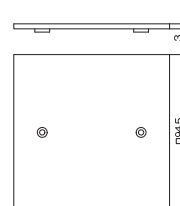

Partition VH-4

Type	Colour	Pack. pcs	Weight kg/100 pcs.	Item No.
VH-4 TW	Graphite black	1	2.350	6109832
PVC	Polyvinylchloride			

Additional partition wall for reciprocal insulation of three different power circuits and types. Version for VH-4.

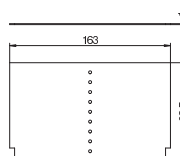

Socket 0°, protective contact, single

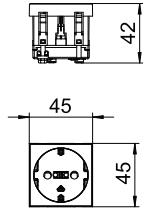

Type	Colour	Pack. Weight		Item No.
		pcs	kg/100 pcs.	
STD-D0 RW1	Pure white	1	4.200	6120008

PC Polycarbonate

Protective contact socket single 0°, with increased touch protection, with screwless terminals, 2-pin, 16 A, 250 V~, with connection terminals to IEC 60884-1.

Socket 33°, protective contact, double

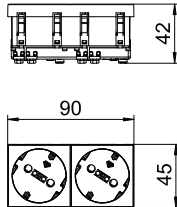

Type	Colour	Pack. Weight		Item No.
		pcs	kg/100 pcs.	
STD-D3 RW2	Pure white	1	7.800	6120102

PC Polycarbonate

Protective contact socket double 33°, with increased touch protection, with screwless terminals, 2-pin, 16 A, 250 V~, with connection terminals to IEC 60884-1.

Socket 0°, with earthing pin, single

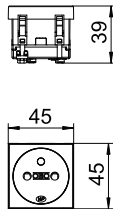

Type	Colour	Pack. Weight		Item No.
		pcs	kg/100 pcs.	
STD-F0 RW1	Pure white	1	4.000	6120152

PC Polycarbonate

Socket with earthing pin single 0°, with increased touch protection with screwless terminals, 2-pin, 16 A, 250 V~, with connection terminals to IEC 60884-1.

Socket 33°, with earthing pin, double

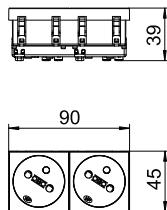

Type	Colour	Pack. Weight		Item No.
		pcs	kg/100 pcs.	
STD-F3 RW2	Pure white	1	7.500	6120242

PC Polycarbonate

Socket with earthing pin double 33°, with increased touch protection with screwless terminals, 2-pin, 16 A, 250 V~, with connection terminals to IEC 60884-1.

Socket 0°, British Standard, single

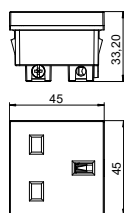

Type	Colour	Pack. Weight		Item No.
		pcs	kg/100 pcs.	
STD-BS0 RW1	Pure white	1	4.000	6120722

PC Polycarbonate

Socket, single 0°, British Standard, conforming to BS 1363, with increased touch protection, with screw terminals, 2-pin, 13 A, 250 V~.

Socket 0°, Switzerland, single

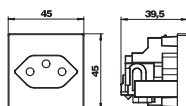

Type	Colour	Pack. Weight		Item No.
		pcs	kg/100 pcs.	
SKS-CH0 RW1	Pure white	1	3.400	6117200

PC Polycarbonate

Socket, single 0°, to Swiss standard (SEV), with screwless terminals, 2-pin, 10 A, 250 V~, type 13, with connection terminals to IEC 60884-1.

Socket 0°, Denmark, single

Type	Colour	Pack. pcs	Weight kg/100 pcs.	Item No.

PC Polycarbonate

Socket, single 0°, to Danish standard, with increased touch protection, with screw terminals, 2-pin, 16 A, 250 V~, with connection terminals to IEC 60884-1.

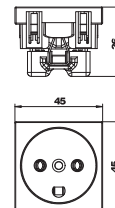

Socket 0°, India, 5 A, single

Type	Colour	Pack. pcs	Weight kg/100 pcs.	Item No.

PC Polycarbonate

Socket, single 0°, India, conforming to BS 546, with increased touch protection, with screw terminals, 2-pin, 5 A, 250 V~.

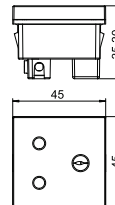

Socket 0°, South Africa/India, 16 A, single

Type	Colour	Pack. pcs	Weight kg/100 pcs.	Item No.

PC Polycarbonate

Socket, single 0°, South Africa/India, conforming to BS 546, with increased touch protection, with screw terminals, 2-pin, 16 A, 250 V~.

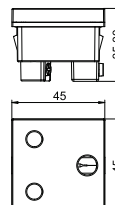

Socket 0°, China, 10 A, single

Type	Colour	Pack. pcs	Weight kg/100 pcs.	Item No.

PC Polycarbonate

Socket, single 0°, China, with increased touch protection, with screw terminals, 2-pin, 10 A, 250 V~.

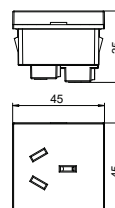

Socket 0°, China, 16 A, single

Type	Colour	Pack. pcs	Weight kg/100 pcs.	Item No.

PC Polycarbonate

Socket, single 0°, China, with increased touch protection, with screw terminals, 2-pin, 16 A, 250 V~.

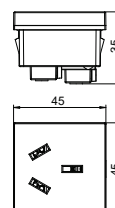

Data technology support, 1 module, slanting outlet, type C

Type	Colour	Pack. pcs	Weight kg/100 pcs.	Item No.

PC Polycarbonate

The type C data technology support is suitable for accepting the following data connection modules: BTR (Keystone design): Cat. 6A module and UAE module; Corning: modules with Keystone seat; CobiNet: CobiDat KS module; Dätwyler: KS-T, KS-TS, MS-K and KU-T; EKU: E-Stone; Harting: Prelink Keystone Cat. 6A; Fixlink Keystone Cat. 6A; Komos: KDM 500 module; Leoni Kerpen: MegaLine-Connect45 Keystone socket modules; OBO: Type ASM-C6A and ASM-C6A G; R&M: Cat. 6A with Keystone fastening; Rutenbeck: UM and UMflex; SETEC: UKJ and XKJ; Telegärtner: AMJ and UMJ.

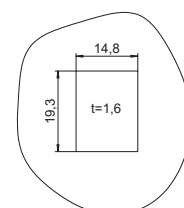
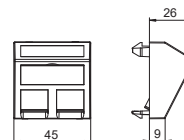

Connection module Cat. 6A, unshielded, snap-In

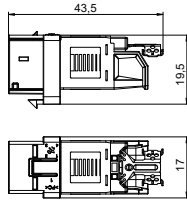

Type

Type	Pack. pcs	Weight kg/100 pcs.	Item No.
ASM-C6A	1	1.050	6117348

Connection module Cat. 6A (ISO) unshielded, with a RJ45 slot. Including a dust cover, a cable tie, a Keystone fastening frame and mounting instructions. Suitable for installation in the data technology supports of type DTG-2C and DTS-2C, support plate of type MTM 2C and MTM 3C, mounting plate of type MPR2 2C, mounting supports of type MTGE2 2C, MTGE2 15 2C and MTGE2 F 2C.

Connection module Cat. 6A, shielded, snap-In

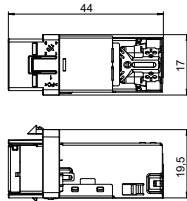

Type

Type	Pack. pcs	Weight kg/100 pcs.	Item No.
ASM-C6A G	1	1.630	6117346

Connection module Cat. 6A (ISO) shielded, with a RJ45 slot. Including an EMC screen hood, a dust cover, a cable tie, a Keystone fastening frame and mounting instructions. Suitable for installation in the data technology supports of type DTG-2C and DTS-2C, support plate of type MTM 2C and MTM 3C, mounting plate of type MPR2 2C, mounting supports of type MTGE2 2C, MTGE2 15 2C and MTGE2 F 2C.

Surface-mounted socket 0° with hinged cover, protective contact, single

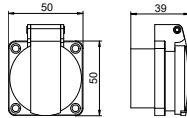

Type

Type	Designation	Colour	Pack. pcs	Weight kg/100 pcs.	Item No.
ASD-D0 SW	prot. contact w. hinged cov.	Black	1	1.000	6109873

Protective contact extension socket 0° with hinged cover, with screwless terminals, 2-pin, 16 A, 250 V~, with connection terminals to IEC 60884-1. Protection rating: IP44.

CEE connection unit, 16 A

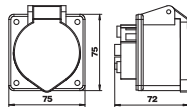

Type

Type	Pack. pcs	Weight kg/100 pcs.	Item No.
CEE-16A	1	19.100	6109874

CEE socket with 60 mm fastening track, 3-pin + N + PE, 400 V, 16 A, 6 h.

CEE connection unit, 32 A

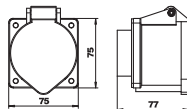

Type

Type	Pack. pcs	Weight kg/100 pcs.	Item No.
CEE-32A	1	20.400	6109876

CEE socket with 60 mm fastening track, 3-pin + N + PE, 400 V, 32 A, 6 h.

VH-8 power supply unit, empty housing

Type	Colour	Pack. pcs	Weight kg/100 pcs.	Item No.
VHF-8 LG	Graphite black	1	105.000	6109822

PA Polyamide

Empty housing with suspension lug and grip hook, for the installation of electrical resources, with included partition. Without cover plates to supply workplaces in wet areas. Protection rating: IP 44.

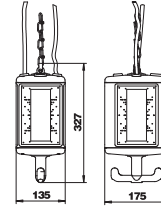

VH-8 power supply unit, empty housing, with compressed air connection

Type	Colour	Pack. pcs	Weight kg/100 pcs.	Item No.
VHF-8L LG	Graphite black	1	400.000	6109827

PA Polyamide

Empty housing with 1 m pipe 1/2" and connection for compressed air hose 13 x 3.5 mm and 2-way distributor 1/2". With suspension lug and grip hook, for the installation of electrical resources, with included partition. Without cover plates to supply workplaces in wet areas. Protection rating: IP 44.

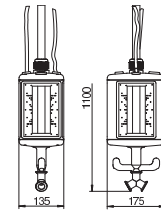

Partition VHF, without compressed air connection

Type	Colour	Pack. pcs	Weight kg/100 pcs.	Item No.
VHF-TW	Graphite black	1	3.520	6109860

PVC Polyvinylchloride

Additional partition wall for reciprocal insulation of three different power circuits and types.

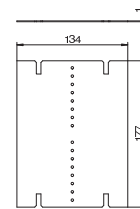

Partition VHF, with compressed air connection

Type	Colour	Pack. pcs	Weight kg/100 pcs.	Item No.
VHF-TW L	Graphite black	1	3.900	6109861

PVC Polyvinylchloride

Additional partition wall for reciprocal insulation of three different power circuits and types.

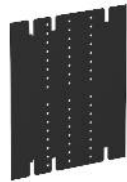
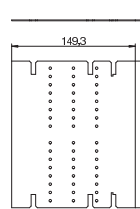

Cover plate VHF as blanking cover

Type	Colour	Pack. pcs	Weight kg/100 pcs.	Item No.
VHF-P1	Rape yellow	1	7.000	6109868

PVC Polyvinylchloride

Cover plate as blanking cover.

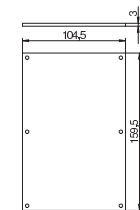

Cover plate VHF 1x with fast. system

Type	Colour	Pack. pcs	Weight kg/100 pcs.	Item No.
VHF-P7	Rape yellow	1	6.600	6109878

PVC Polyvinylchloride

Cover plate with opening for the installation of a socket with 38 x 38 mm fastening system.

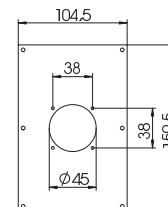

Cover plate VHF, for 1x extension socket, type ASD

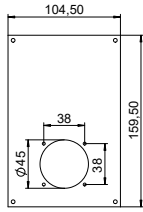

Type	Colour	Pack. Weight		Item No.
		pcs	kg/100 pcs.	
VHF-P12	Rape yellow	1	7.400	6109856

PVC Polyvinylchloride

Cover plate with a \varnothing 45 mm opening for the installation of an extension socket (type ASD-...) with 38 mm fastening track, including 4 screws for fastening the device.

Cover plate VHF, for 2x extension socket, type ASD

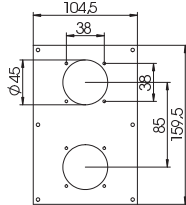

Type	Colour	Pack. Weight		Item No.
		pcs	kg/100 pcs.	
VHF-P8	Rape yellow	1	5.900	6109879

PVC Polyvinylchloride

Cover plate with two \varnothing 45 mm openings for the installation of two extension sockets (type ASD-...) with 38 mm fastening track, including 8 screws for fastening the device.

Cover plate VHF, for CEE connection unit

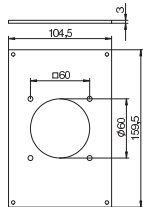

Type	Colour	Pack. Weight		Item No.
		pcs	kg/100 pcs.	
VHF-P3	Rape yellow	1	7.000	6109865

PVC Polyvinylchloride

Cover plate with a \varnothing 70 mm opening for the installation of 1x CEE socket 16/32 A with 60 mm fastening track, including 4 screws for fastening the device.

Cover plate VHF, for 1x extension socket, type ASD and 1x CEE connection

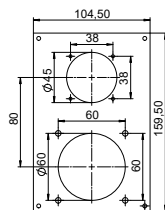

Type	Colour	Pack. Weight		Item No.
		pcs	kg/100 pcs.	
VHF-P13	Rape yellow	1	7.400	6109858

PVC Polyvinylchloride

Cover plate with a \varnothing 45 mm opening for the installation of one extension socket (type ASD-...) with 38 mm fastening track and a \varnothing 60 mm opening for the installation of one CEE socket 16/32 A with 60 mm fastening track, including 8 screws for fastening the device.

Cover plate VHF for protective equipment installation

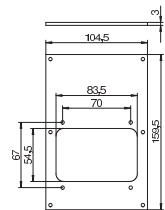

Type	Colour	Pack. Weight		Item No.
		pcs	kg/100 pcs.	
VHF-P6	Rape yellow	1	4.700	6109867

PVC Polyvinylchloride

Cover plate with cut out for the installation of a cover above protection unit (type VHF-AE4TE). Maximum equipment corresponds to four units.

Cover plate for the VHF power supply units for the installation of a cover above protection unit (type VHF-AE4TE). Maximum equipment corresponds to four units.

VHF protective unit construction, support with PE terminal strip

Type	Pack. pcs	Weight kg/100 pcs.	Item No.
VHF-T1	1	6.730	6109852

St Steel

Support with PE terminal strip for installation of FI protection switches, consisting of:
 - Base element with hat rail 35 mm and PE terminal strip 4 x 10 mm²
 - Fastening material

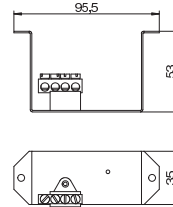

VHF protective unit construction, support with N + PE terminal strip

Type	Pack. pcs	Weight kg/100 pcs.	Item No.
VHF-T2	1	8.380	6109854

St Steel

Support with N and PE terminal strip for installation of miniature circuit-breakers, consisting of:
 - Base element with hat rail 35 mm, N terminal strip 4 x 10 mm² and PE terminal strip 4 x 10 mm²
 - Fastening material

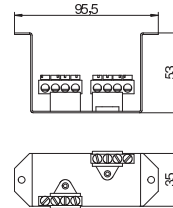

Surface-mounted socket 0° with hinged cover, protective contact, single

Type	Designation	Colour	Pack. pcs	Weight kg/100 pcs.	Item No.
ASD-D0 SW	prot. contact w. hinged cov.	Black	1	1.000	6109873

Protective contact extension socket 0° with hinged cover, with screwless terminals, 2-pin, 16 A, 250 V~, with connection terminals to IEC 60884-1. Protection rating: IP44.

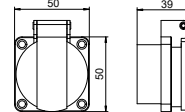

CEE connection unit, 16 A

Type	Pack. pcs	Weight kg/100 pcs.	Item No.
CEE-16A	1	19.100	6109874

CEE socket with 60 mm fastening track, 3-pin + N + PE, 400 V, 16 A, 6 h.

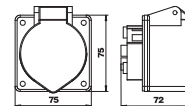

CEE connection unit, 32 A

Type	Pack. pcs	Weight kg/100 pcs.	Item No.
CEE-32A	1	20.400	6109876

CEE socket with 60 mm fastening track, 3-pin + N + PE, 400 V, 32 A, 6 h.

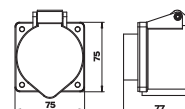

Tension spring VH/VHF

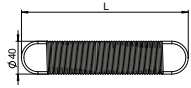

Type

VH-F100VA

V2A Stainless steel, grade 301

Tension spring for VH/VHF power supply units, with German eyelet.

Fmax. = 100 N

L0 = 200 mm

Ln = 500 mm (for Fmax.)

Material: VA Ø 3.0 mm

Pack.	Weight		Item No.
	pcs	kg/100 pcs.	
1	31.000		6109829

Knotted chain

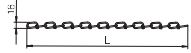

Type

VH-K800 | sold by the metre

SI Steel

Knotted chain made of pre-copper-plated steel, nickel-plated, according to DIN 5686.

Max. tensile force: 800 N.

Note: Specify the required chain length during ordering.

Pack.	Weight		Item No.
	m	kg/100 m	
1	20.000		6109870

Positioner for VH power supply units

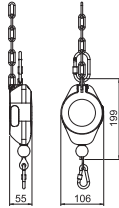

Type

VH-POS | up to 6 kg load capacity

Colour

Orange

Positioner for variable height adjustment of a VH power supply unit, support load between 0.5 and 6.0 kg, maximum cable draw-out 1.5 m.

Pack.	Weight		Item No.
	pcs	kg/100 pcs.	
1	80.000		6109887





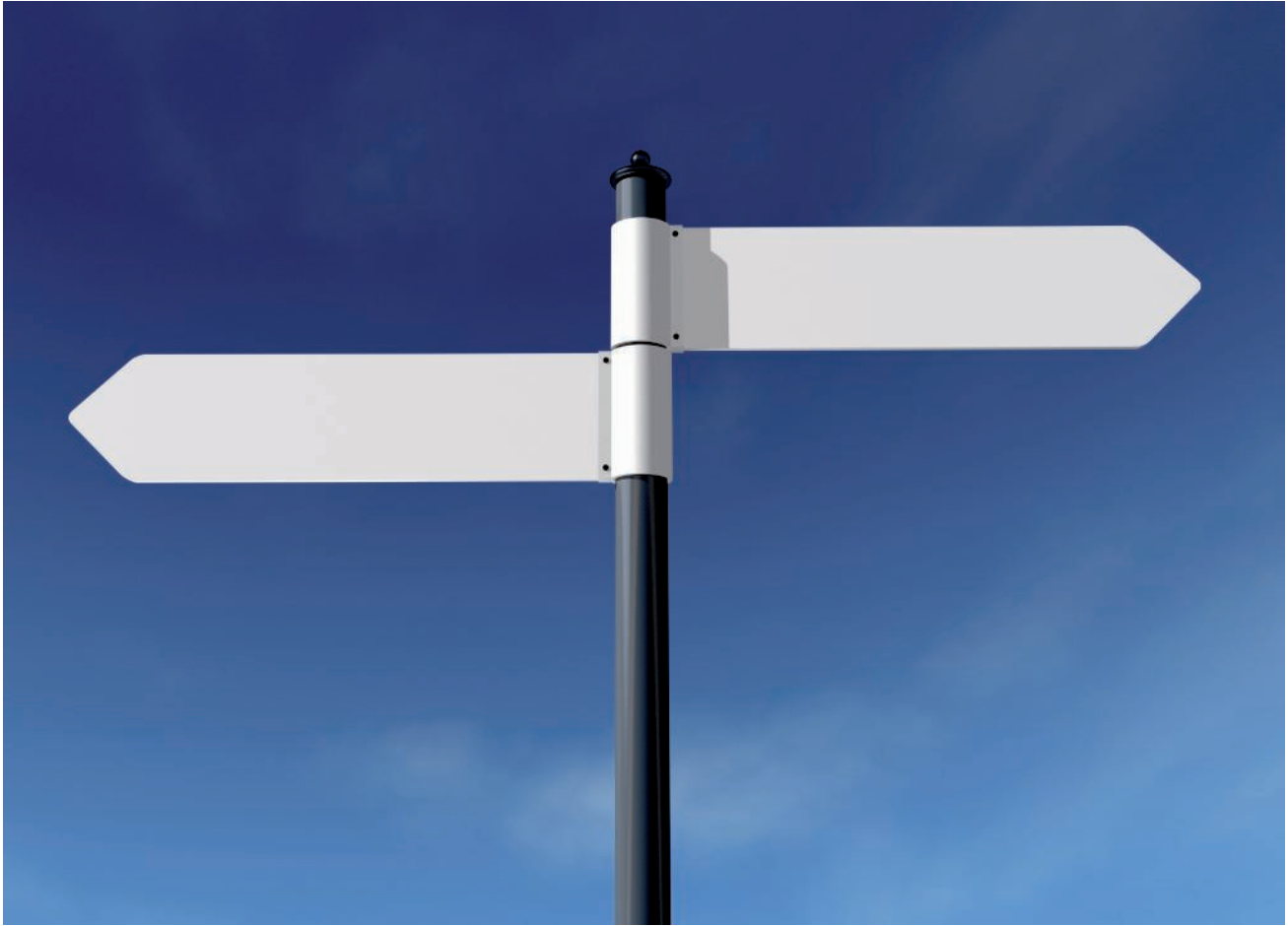





Directories

	Numeric directory	126
	Type listing	128
	Terms and conditions of sale and delivery	134



OBO Bettermann Holding GmbH & Co. KG
P.O. Box 1120
58694 Menden
GERMANY

Customer Service
Tel.: +49 (0)2373 89-1700
Fax: +49 (0)2373 89-1238
export@obo.de

Building Connections

